

# ***design2machine***

*BTLx interface description*

*Version: BTLx 2.3*

*Last modified: 22.11.2024*

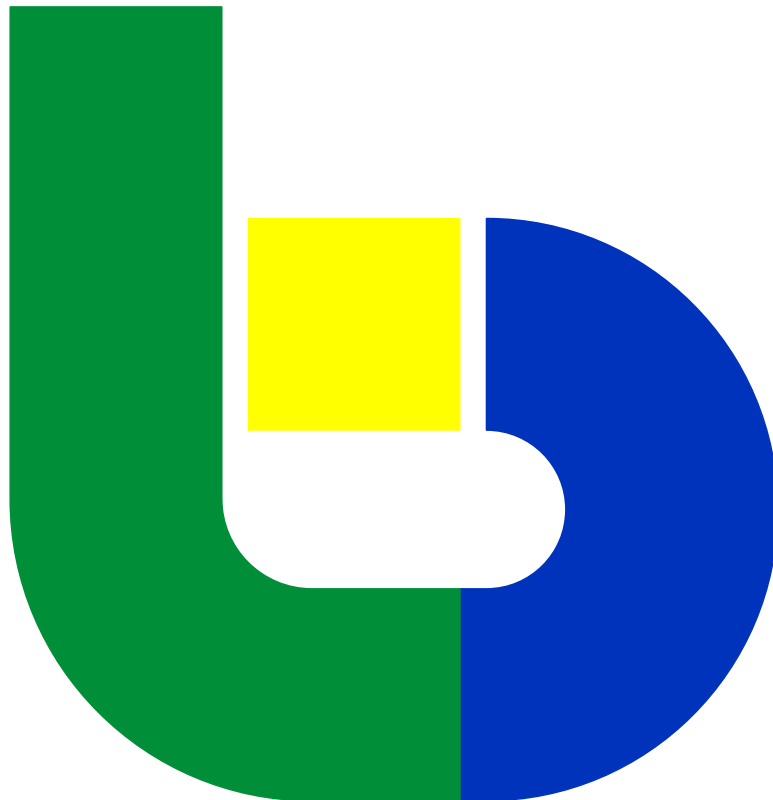

## Common Data Interface for Wood Working Machines

The following interface description is designed for the structured representation of the data relevant to the manufacturing process.

It does not contain any machine specific data. This allows the interface to be used as a common data interface.

If there is a need to prepare the data stored in this interface for some special wood working machine or some special control, then these data should be imported by a suitable CAM system and then properly processed.

This documentation is a graphical appendix to the BTLX schema. You can find this schema at

[https://www.design2machine.com/btlx/BTLx\\_2\\_2\\_0.xsd](https://www.design2machine.com/btlx/BTLx_2_2_0.xsd)

BTLx files are identified by the ".btlx" file extension.

A BTLx file contains general data related to the project, information about the building elements as well as the relationship between them and parametric descriptions of the processings of each building element.

In order to minimize storage space requirements, the specification defines compressed BTLx files which are identified by the ".btlz" file extension. Such a file has to be a standard zip file and may only contain a single BTLx file.

For more information or questions regarding the BTLx format, please contact:

[www.design2machine.com](http://www.design2machine.com)  
[info@design2machine.com](mailto:info@design2machine.com)

## Content

	Page
History	3
General	4
ReferenceSide	5
ReferencePlane	6
List of processings	8
Description of processings	9
Prefabrication	102

## History

You can find the history of the BTLx schema here:

[https://www.design2machine.com/btlx/documentation/BTLx\\_10.html](https://www.design2machine.com/btlx/documentation/BTLx_10.html)  
[https://www.design2machine.com/btlx/documentation/BTLx\\_11.html](https://www.design2machine.com/btlx/documentation/BTLx_11.html)  
[https://www.design2machine.com/btlx/BTLx\\_2\\_0\\_0.xsd](https://www.design2machine.com/btlx/BTLx_2_0_0.xsd)  
[https://www.design2machine.com/btlx/BTLx\\_2\\_1\\_0.xsd](https://www.design2machine.com/btlx/BTLx_2_1_0.xsd)  
[https://www.design2machine.com/btlx/BTLx\\_2\\_2\\_0.xsd](https://www.design2machine.com/btlx/BTLx_2_2_0.xsd)  
[https://www.design2machine.com/btlx/BTLx\\_2\\_3\\_0.xsd](https://www.design2machine.com/btlx/BTLx_2_3_0.xsd)

And here the history of the graphical documentation:

Date	Modification	Build	Page
23.03.2017	Lap: Definition of LeadAngle and LeadInclination	1.0	30, 31
23.03.2017	Birdsmouth: Definition of LeadAngle and LeadInclination	1.0	23, 24
13.06.2017	LongitudinalCut: Changed definiton of ToolPosition	1.0	11
06.11.2018	RidgeValleyCut: StartDepht can also be < 0	1.0	16
16.09.2019	Dovetail: Better description	1.0	58,59,60
19.05.2017	New Element for Shape. Geometry of part in X3D Format	1.1	105
17.11.2017	Birdsmouth: Correction at LeadAngle and LeadInclination	1.1	23, 24
26.07.2019	Dovetail: Better description	1.1	58,59,60
04.03.2020	SawCut: Changed limit of Angle from 0/+180 to -180/+180	1.1	18
20.07.2020	Japanese Tenon	2.0	64
20.07.2020	Japanese Mortise	2.0	62
20.07.2020	NURBSCurve	2.0	106
20.07.2020	NURBSPatch	2.0	106
20.07.2020	Face limited top or Bottom	2.0	105
20.07.2020	X3D Shape	2.0	8
20.07.2020	SawCut Limits	2.0	19
26.10.2020	Contour: Better description for Depth and DepthBounded	2.0	104, 105
26.10.2020	House: Better description for StartDepth	2.0	54
05.11.2020	Remark: Part attributes "Count" and "Transformations"	2.0	4
05.11.2020	Tenon: description for LengthLimitedTop and LengthLimitedBottom	2.0	51
05.11.2020	Contour: Correlation between ContourType and Line attributes	2.0	104
06.11.2020	Mortise: description for LengthLimitedTop and LengthLimitedBottom	2.0	53
09.07.2021	Graphically corrections: sawcut (Machine limits) and lap (No StartDepth)	2.0	19, 33
28.12.2021	Annotations: Processings, which trim the part	2.1.0	11,14,38,45,70,72,75,92,103
28.12.2021	Types of Rawparts	2.1.0	4
28.12.2021	Contour: CrampAngleRefType	2.1.0	108
11.01.2022	RecessAdvType: Description	2.1.0	7
10.03.2022	Changed attribute from FaceLimitedFront to FaceLimitedStart	2.1.0	19
05.07.2022	Slot: Deleted unused measurement	2.1.0	20
09.12.2022	DovetailMortise: description for Angle, Slope and Inclination	2.0	60
14.09.2023	Better description of Transformation and Reference	2.1.0	7
08.11.2023	Corrections	2.1.0	74,75,76,77,92,100
10.11.2023	ProfileHead: Correction convex / concave	2.1.0	87
05.09.2023	Mortise, DovetailMortise, Housemortise: Sequence of Angle, Slope and Inclination	2.2.0	53, 61
24.11.2023	RdigeValleyCut: Included "Edge" in 4 names of angles in face	2.2.0	16, 17
04.12.2023	Lap Joint: Location of LeadAngle, another case	2.2.0	31, 32
04.03.2024	New description of Location of LeadAngle, BirdsMouth and Lap Joint	2.2.0	24, 25, 31, 32
09.10.2024	Rewriting terms like SimpleContour or ContourType	2.2.0	104
30.10.2024	Contour: discription of FaceLimited	2.2.0	105
22.11.2024	Contour: discription of FaceLimited	2.3.0	105

# General

These drawings are a graphical appendix to the description in the XML schema.

## Recess

Recess = automatic

Recess = manual

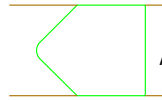
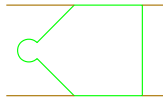

Additional manual work is necessary.

Presentation is schematic / exemplarily

## RecessAdvType

enumeration value =

Primarily for:

- Lap
- Pocket
- Mortise

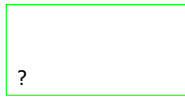

automatic

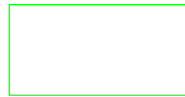

exact



directionWidth

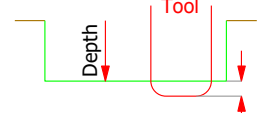

directionDepth



manual

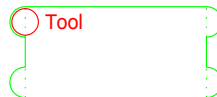

directionLength

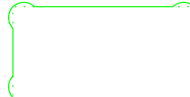

directionDiagonal

Presentation is schematic / exemplarily

## PartType

RawPartEnumType  
enumeration value = nesting

RawPart

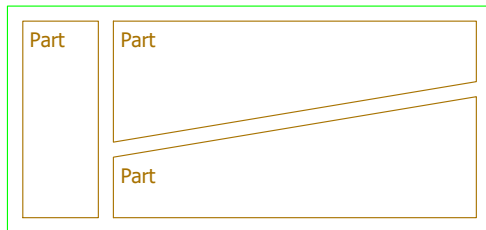

enumeration value = blank

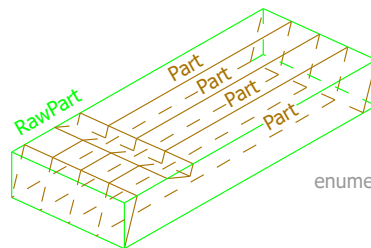
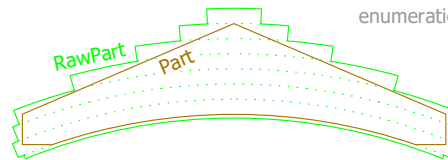

enumeration value = package

RawPart

enumeration value = beam



## AligmentType

LocationType

- = bottomRail
- or topRail
- or bottomRailAngled
- or topRailAngled
- or horizontalComponent
- or verticalComponent
- or angledComponent

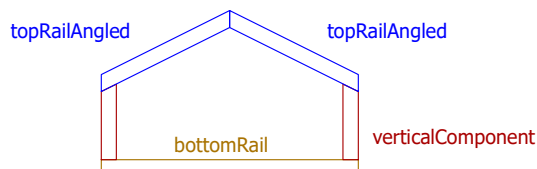
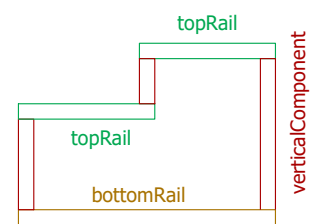
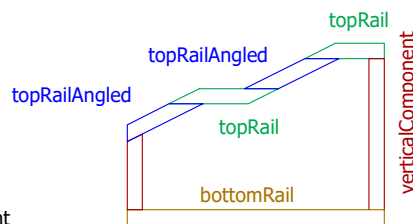

## Part attributes "Count" and "Transformations"

If Count > 1 for a part, there have to be Count Transformations.  
Each Transformation must have an own GUID.  
GUID must be unique.

This condition is **not** controlled by the XML schema.  
This condition is controlled by the XML schema.  
This condition is **not** controlled by the XML schema.

# ReferenceSide

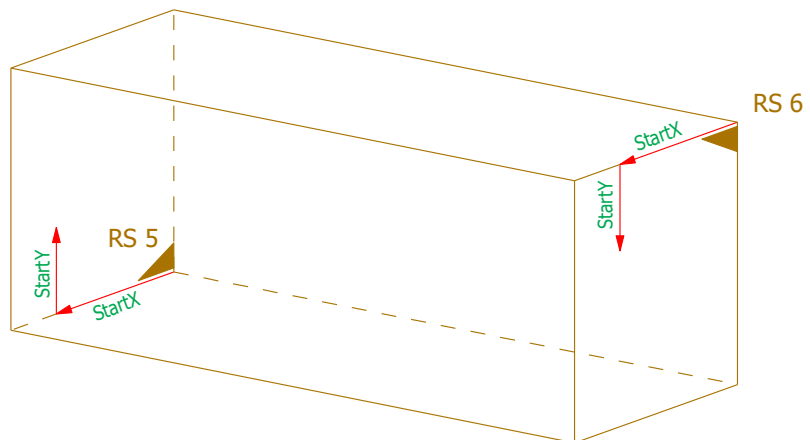
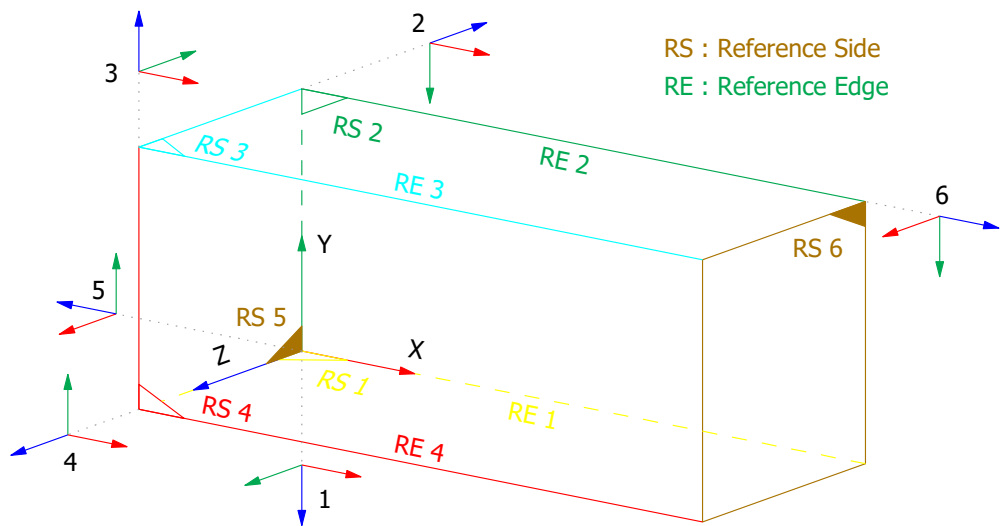
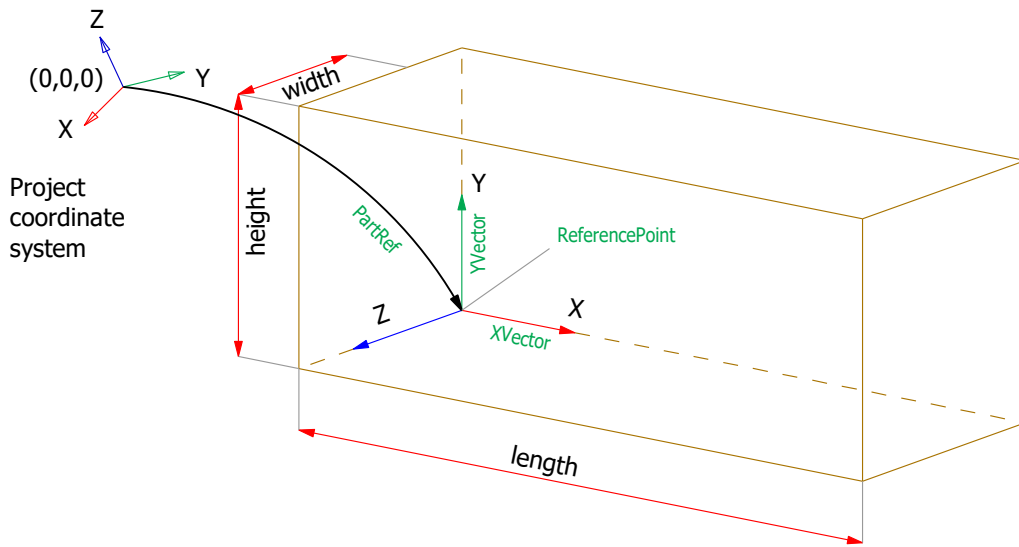

## Referenceplane

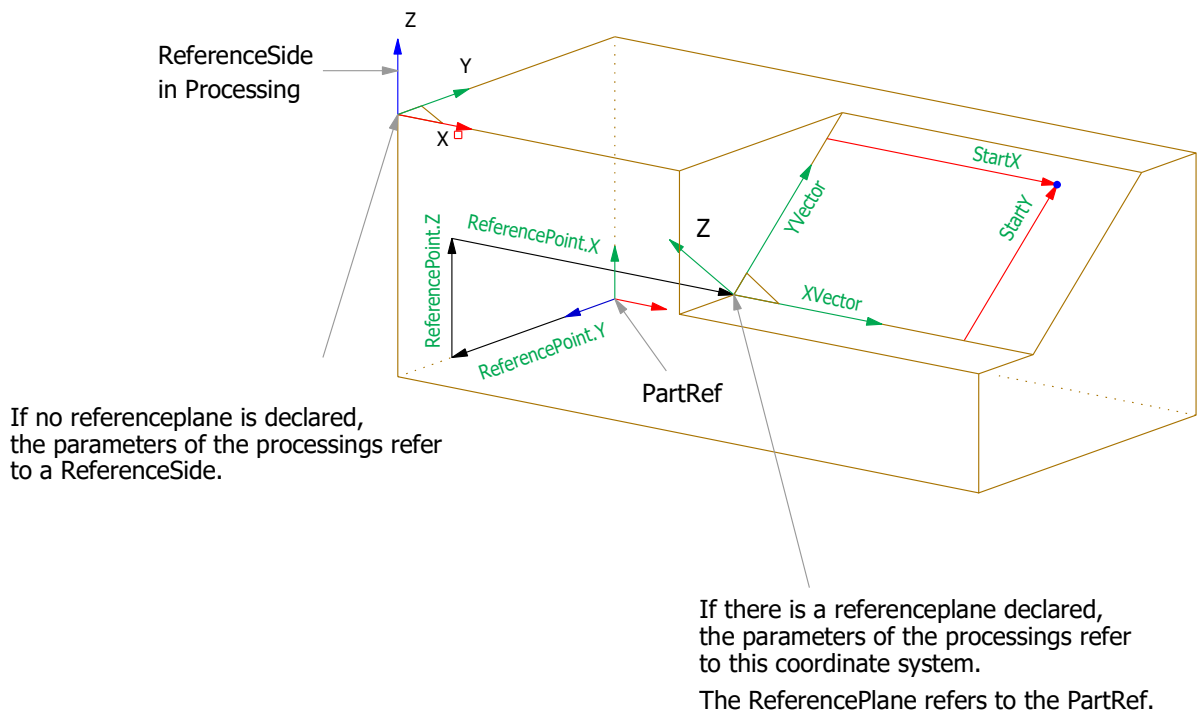

## View

Most of the processings are drawn by a view orthogonal to the reference side. Otherwise the zeropoint of the reference side is displayed with a brown line.

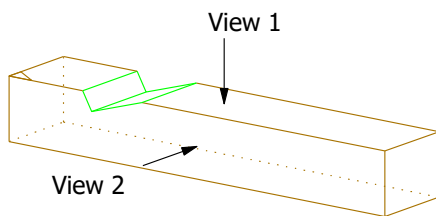

View 1



View 2

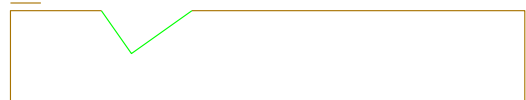

### Transformation and Reference at Rawparts

Rawpart belongs mostly not to the project.  
It is for manufacture.

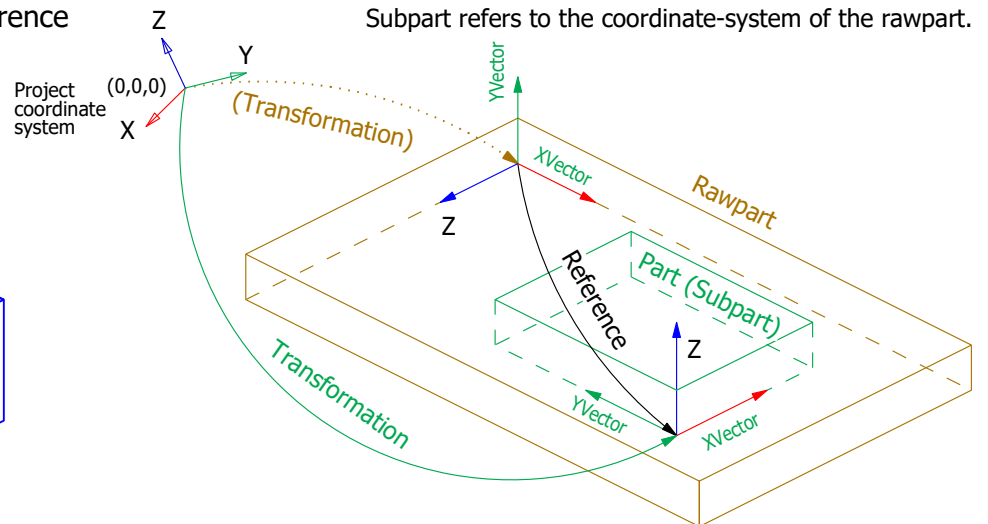
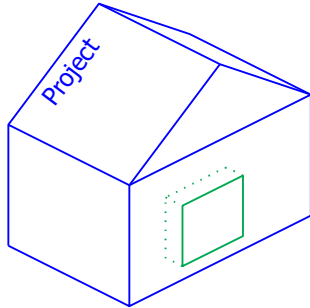

### Transformation, Reference at Composites

MODULE, LAYER, ELEMENT belong to the project.

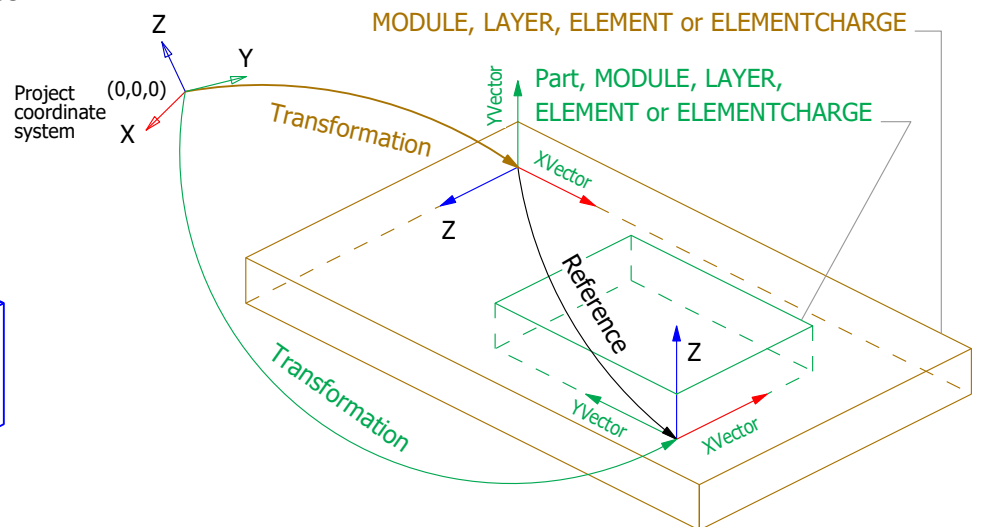
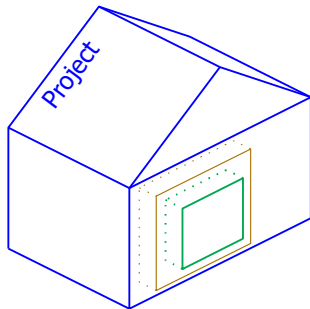

### Camber

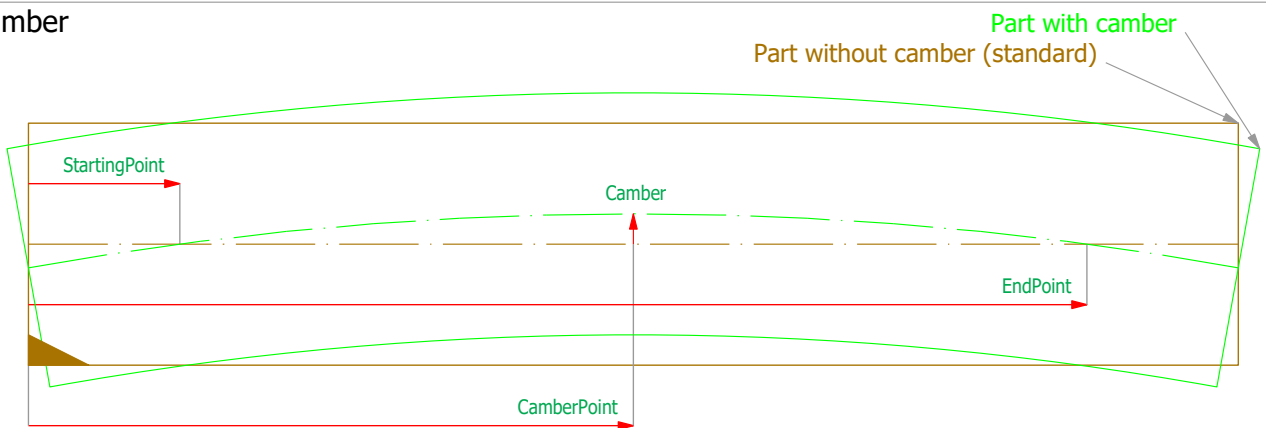

All processings are defined in the part without camber.

### X3D Shape

With the Element <Shape> you can define the geometry of a part.

A part is build with several faces. The volume is closed.

All points of a face are coplanar and counterclockwise.

The coordinates of the points refer to the ReferencePoint of the part.

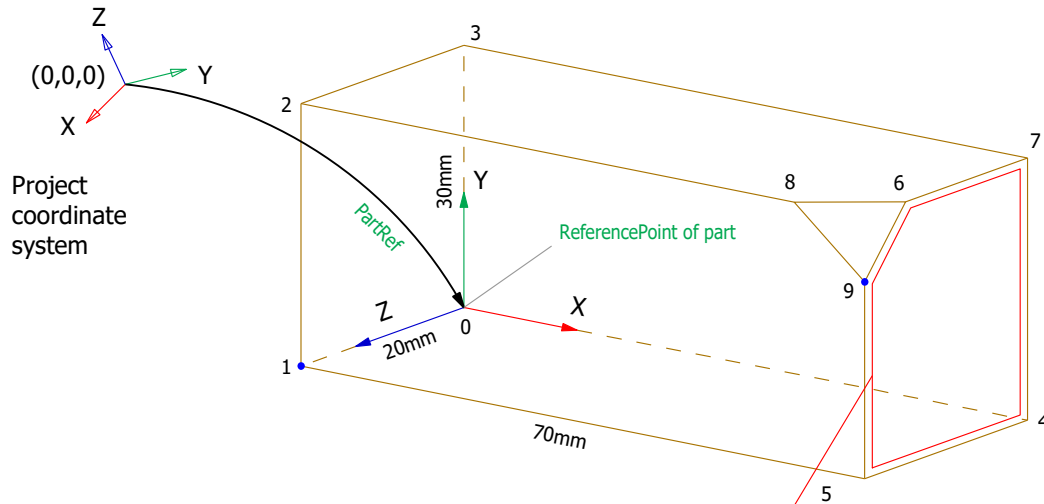

```
<?xml version="1.0" encoding="utf-8" standalone="yes"?>
<X3D profile="CADInterchange" version="3.3" xmlns:xsd="http://www.w3.org/2001/XMLSchema-instance" xsd:noNamespaceSchemaLocation=
"http://www.web3d.org/specifications/x3d-3.3.xsd">
<head/>
<Scene>
  <Shape>
    <Appearance>
      <Material diffuseColor="0.6 0.6 0.6" emissiveColor="0.4 0.4 0.4"/>
    </Appearance>
    <IndexedFaceSet convex="false" coordIndex="0 1 2 3 -1 4 7 6 9 5 -1 1 5 9 8 2 -1 2 8 6 7 3 -1 3 7 4 0 -1 0 4 5 1 -1 9 6 8 -1">
      <Coordinate point="0.0 0.0 0.0 0.0 0.0 20.0 0.0 30.0 20.0 0.0 30.0 0.0 70.0 0.0 0.0 70.0 0.0 20.0 70.0 30.0 15.0 70.0 30.0 0.0 61.25 30.020 70.0 22.5 20"/>
    </IndexedFaceSet>
  </Shape>
</Scene>
</head>
</X3D>
```

a face  
Separator between 2 faces

point 1    x    y    z

point 9



## List of Processings

Processing	Page
JackRafterCut	10
LongitudinalCut	12
DoubleCut	14
RidgeValleyCut	16
SawCut	18
Slot	20
BirdsMouth	24
HipValleyRafterNotch	29
Lap	31
LogHouseHalfLap	35
FrenchRidgeLap	37
Chamfer	39
LogHouseJoint	41
LogHouseFront	44
Pocket	46
Drilling	48
Tenon	50
Mortise	52
House	54
HouseMortise	56
DovetailTenon	58
DovetailMortise	60
Japanese Mortise	62
Japanese Tenon	64
Marking	66
Text	68
SimpleScarf	70
ScarfJoint	72
StepJoint	74
StepJoint Notch	76
Planing	78
ProfileFront	80
ProfileCambered	82
RoundArch	84
ProfileHead	86
Sphere	88
TriangleCut	90
TyroleanDovetail	92
Dovetail	101
Contour, some definitions	104
NURBS Curve	106
NURBS Patch	106
Composite	109

### JackRafterCut

Orientation = start

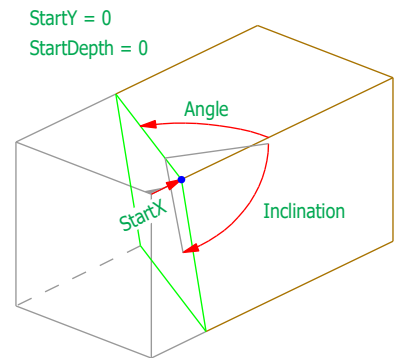
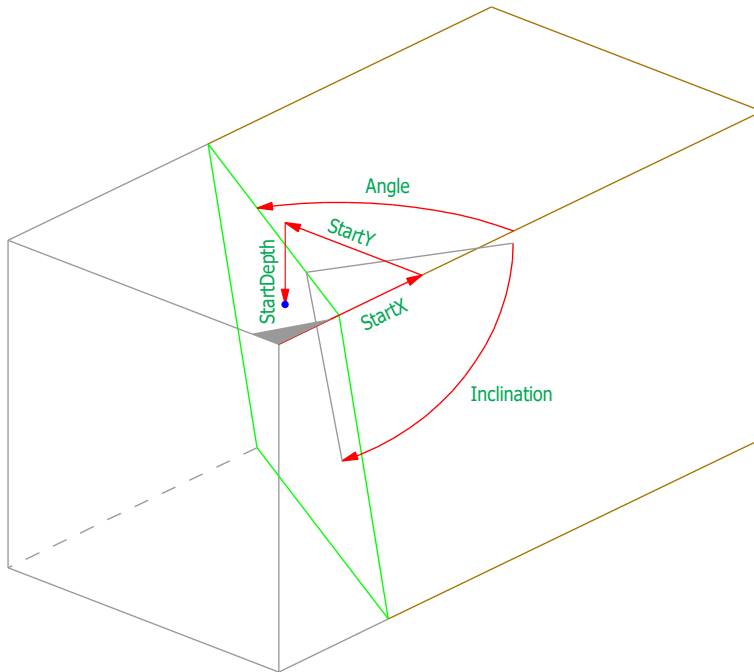

Orientation = end

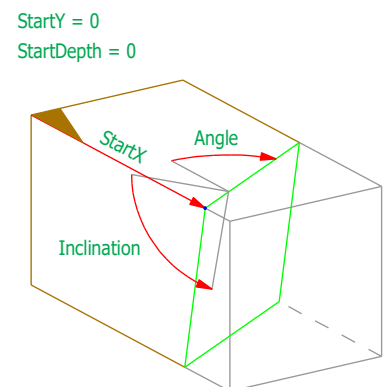
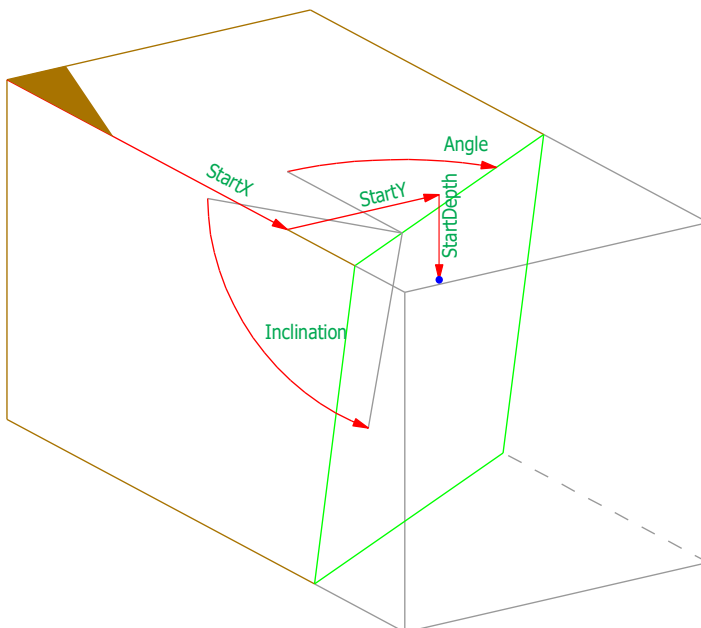

## Parameters JackRafterCut

Name	Type	Default	Min	Max
Orientation	OrientationType		start	end
StartX	LengthPosType	0.0	-100000.0	100000.0
StartY	WidthType	0.0	0.0	50000.0
StartDepth	WidthType	0.0	0.0	50000.0
Angle	AngleType	90.0	0.1	179.9
Inclination	AngleType	90.0	0.1	179.9

This processing trims the part, even it is on a ReferencePlane

Examples:



### LongitudinalCut

Inclination > 0

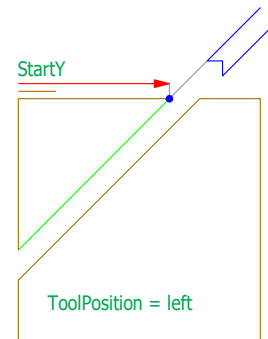
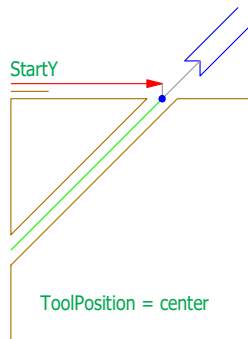
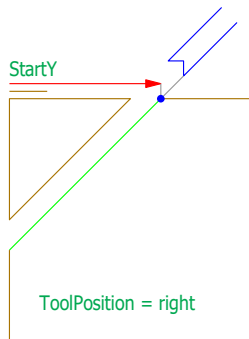
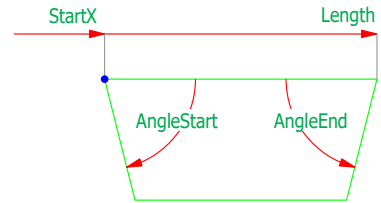
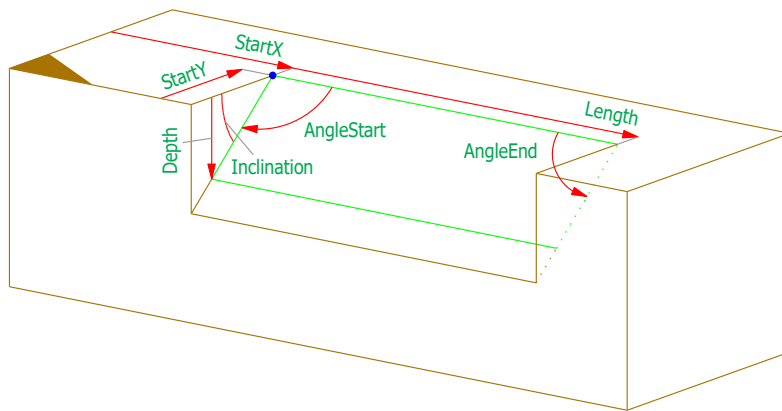

Inclination < 0

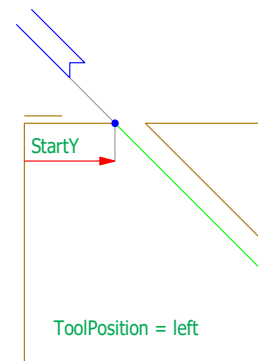
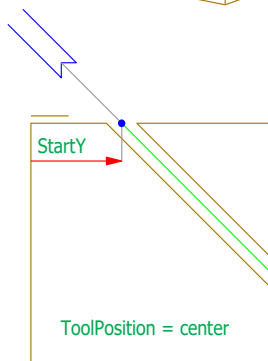
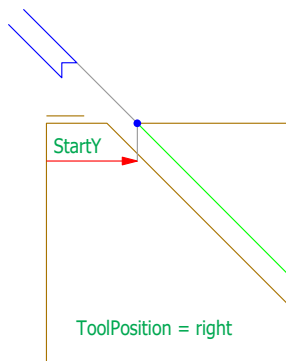
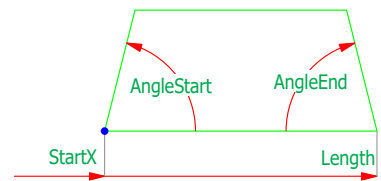
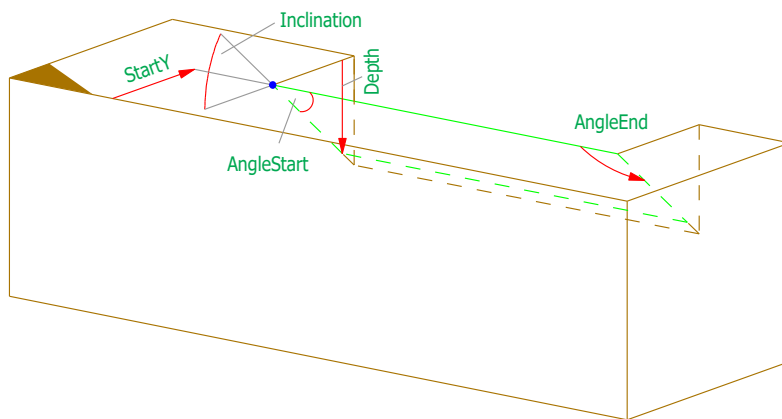

Parameters Longitudinal Cut

Name	Type	Default	Min	Max
StartX	LengthPosType	0.0	-100000.0	100000.0
StartY	WidthType	0.0	0.0	50000.0
Inclination	Inclination2Type	45.0	-90.0	90.0
StartLimited	BooleanType	no	no	yes
EndLimited	BooleanType	no	no	yes
Length	LengthType	0.0	0.0	100000.0
DepthLimited	BooleanType	no	no	yes
Depth	WidthType	0.0	0.0	50000.0
AngleStart	AngleType	90.0	0.1	179.9
AngleEnd	AngleType	90.0	0.1	179.0
ToolPosition	ToolPositionType	left	left/center/right	

StartLimited	EndLimited	
yes	yes	
no	yes	
yes	no	
no	no	

### DoubleCut

Orientation = start

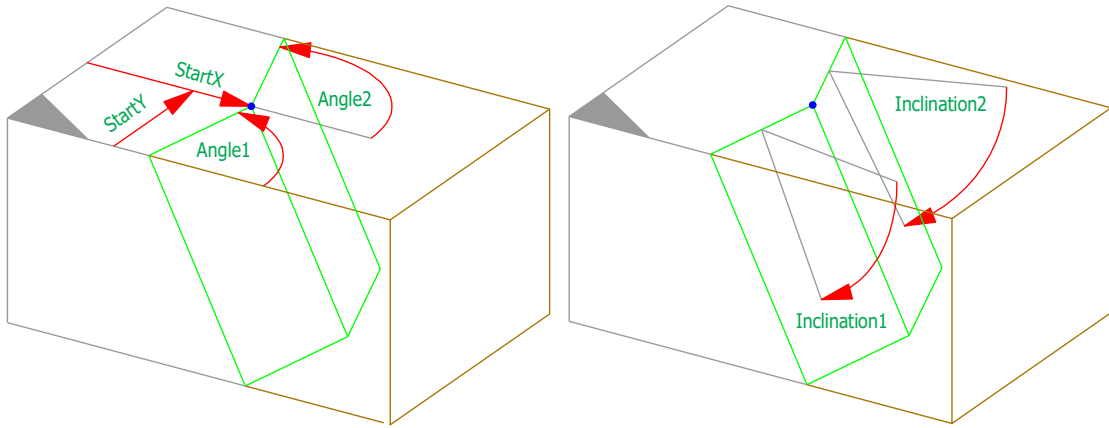

Orientation = end

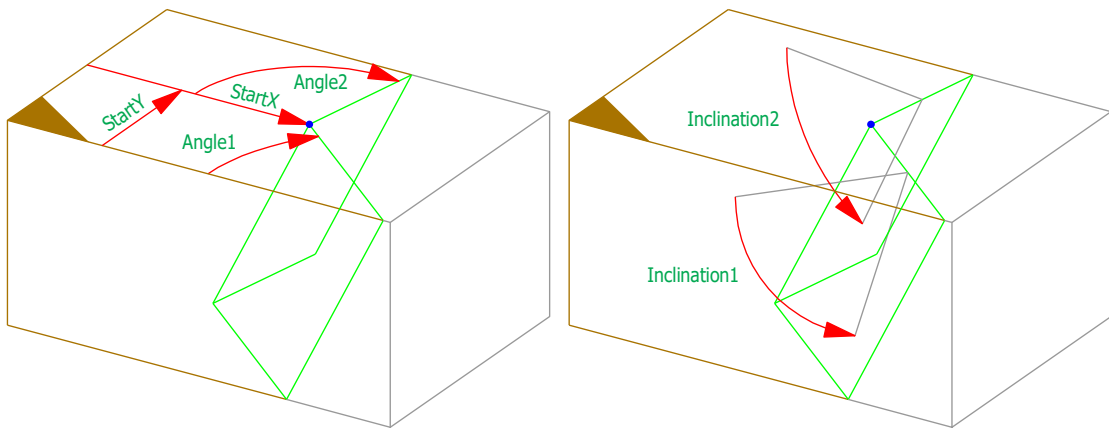

This processing trims the part, even it is on a ReferencePlane

Examples:



## Parameters Double Cut

Name	Type	Default	Min	Max
Orientation	OrientationType		start	end
StartX	LengthPosType	0.0	-100000.0	100000.0
StartY	WidthNType	50.0	-50000.0	50000.0
Angle1	AngleType	45.0	0.1	179.9
Inclination1	AngleType	90.0	0.1	179.9
Angle2	AngleType	90.0	0.1	179.9
Inclination2	AngleType	90.0	0.1	179.9



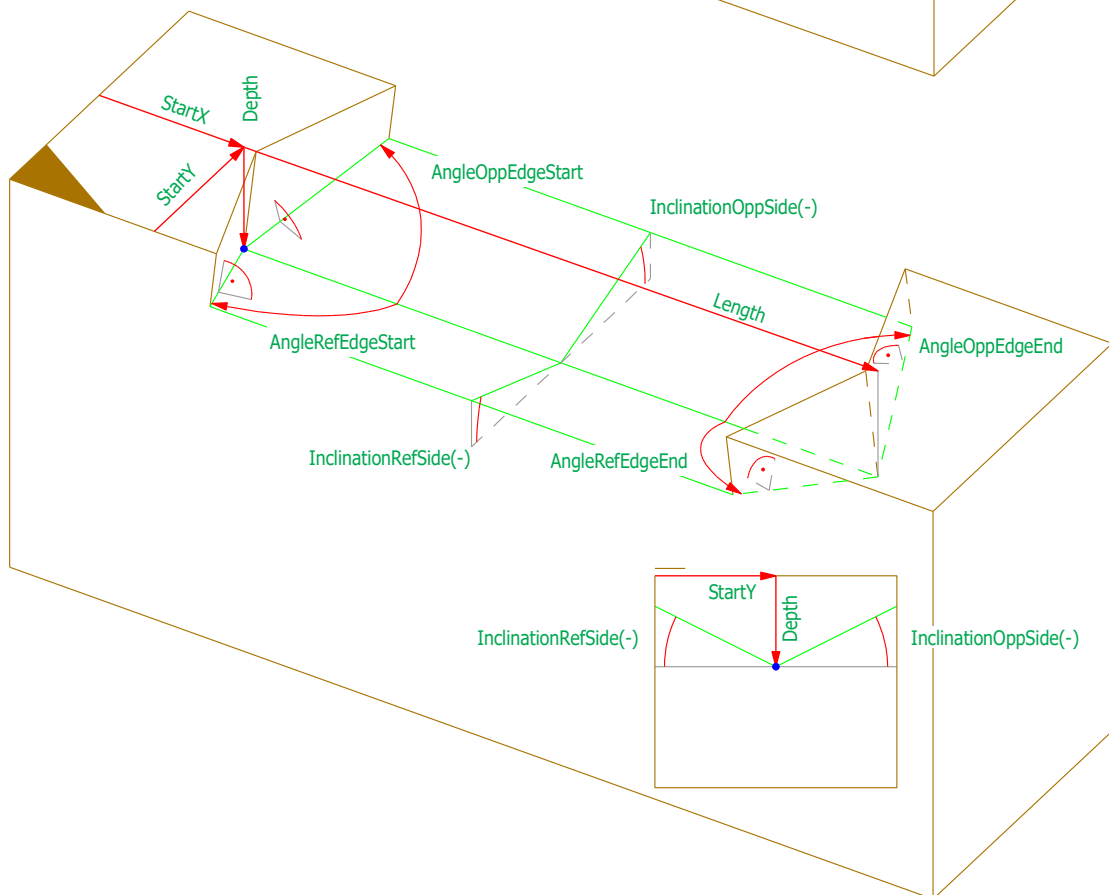
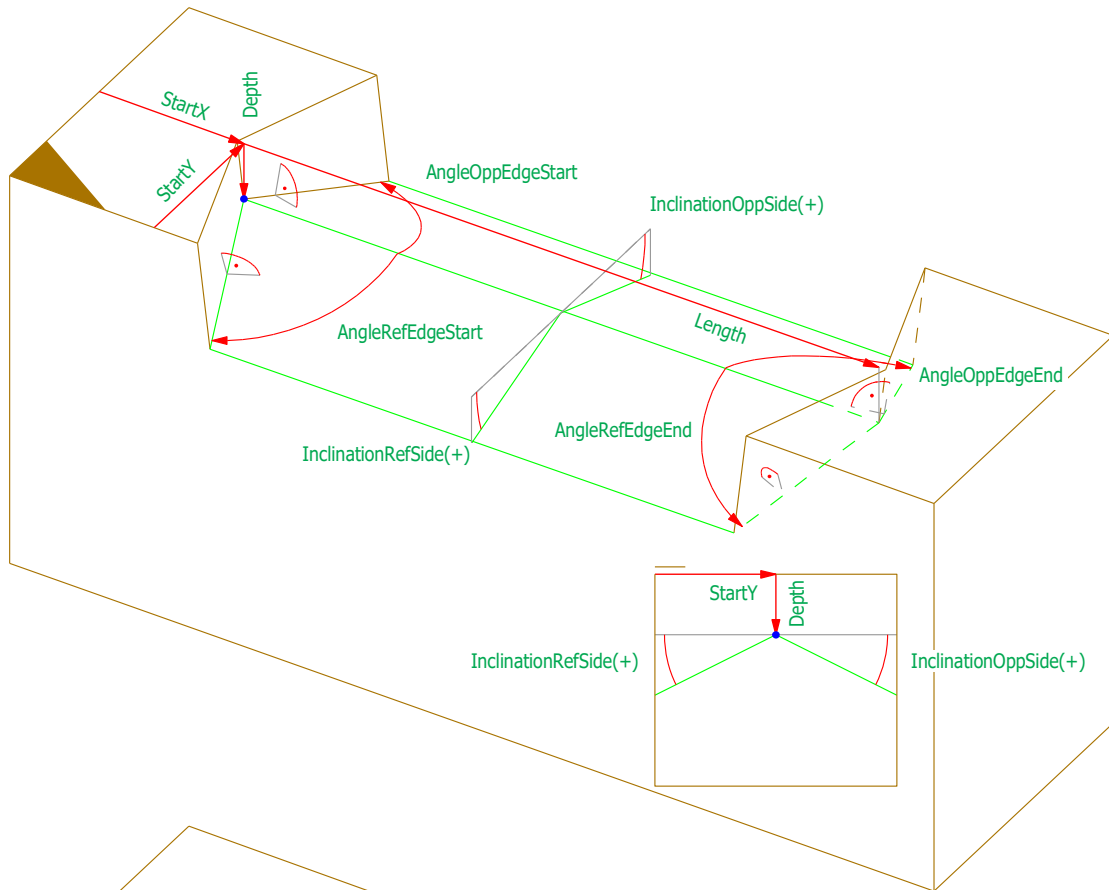

### RidgeValleyCut



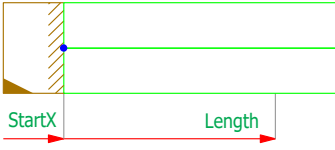

Parameters RidgeValleyCut

Name	Type	Default	Min	Max																								
StartX	LengthPosType	0.0	-100000.0	100000.0																								
StartY	WidthType	50.0	0.0	50000.0																								
StartDepth	WidthNType	0.0	-50000.0	50000.0																								
InclinationRefSide	InclinationType	45.0	-89.9	89.9																								
InclinationOppSide	InclinationType	45.0	-89.9	89.9																								
StartLimited	BooleanType	no	no	yes																								
EndLimited	BooleanType	no	no </tr <tr> <td>Length</td> <td>LengthType</td> <td>0.0</td> <td>0.0</td> <td>100000.0</td> </tr> <tr> <td>AngleRefEdgeStart</td> <td>AngleType</td> <td>90.0</td> <td>0.1</td> <td>179.9</td> </tr> <tr> <td>AngleRefEdgeEnd</td> <td>AngleType</td> <td>90.0</td> <td>0.1</td> <td>179.9</td> </tr> <tr> <td>AngleOppEdgeStart</td> <td>AngleType</td> <td>90.0</td> <td>0.1</td> <td>179.9</td> </tr> <tr> <td>AngleOppEdgeEnd</td> <td>AngleType</td> <td>90.0</td> <td>0.1</td> <td>179.9</td> </tr>	Length	LengthType	0.0	0.0	100000.0	AngleRefEdgeStart	AngleType	90.0	0.1	179.9	AngleRefEdgeEnd	AngleType	90.0	0.1	179.9	AngleOppEdgeStart	AngleType	90.0	0.1	179.9	AngleOppEdgeEnd	AngleType	90.0	0.1	179.9
Length	LengthType	0.0	0.0	100000.0																								
AngleRefEdgeStart	AngleType	90.0	0.1	179.9																								
AngleRefEdgeEnd	AngleType	90.0	0.1	179.9																								
AngleOppEdgeStart	AngleType	90.0	0.1	179.9																								
AngleOppEdgeEnd	AngleType	90.0	0.1	179.9																								

StartLimited	EndLimited	
yes	yes	
no	yes	
yes	no	
no	no	

### SawCut

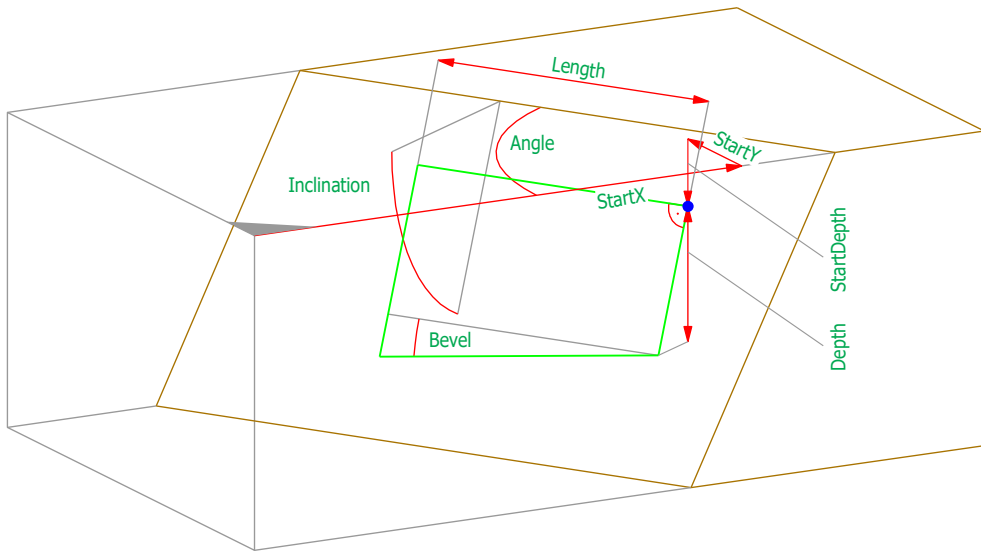

ToolPosition = left

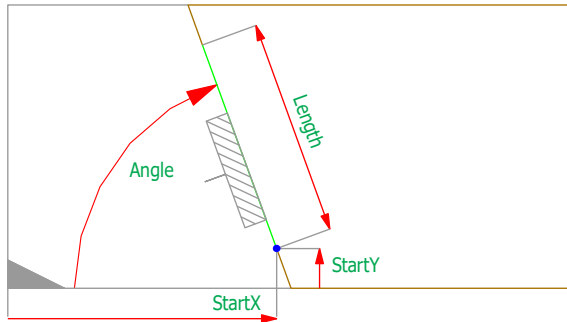

ToolPosition = right

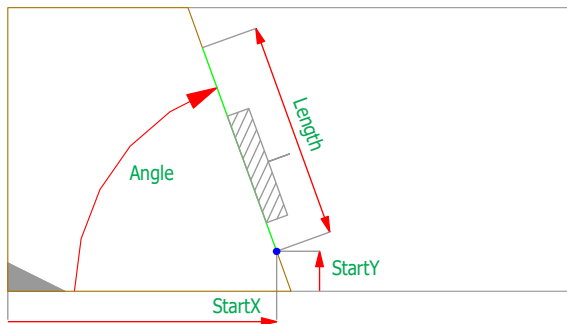

ToolPosition = center

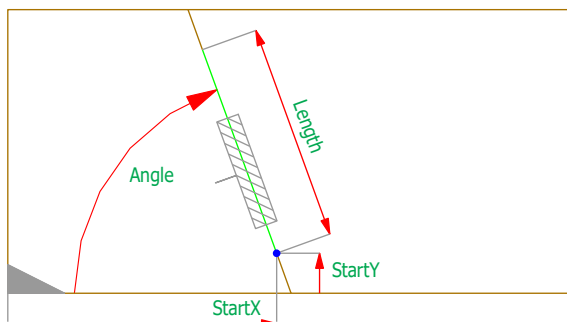

Parameters SawCut

Name	Type	Default	Min	Max
StartX	LengthPosType	0.0	-100000.0	100000.0
StartY	WidthNType	0.0	-50000.0	50000.0
StartDepth	WidthNType	0.0	-50000.0	50000.0
Angle	Angle2Type	90.0	-180.0	180.0
Inclination	AngleType	90.0	0.1	179.9
Bevel	InclinationType	0.0	-89.9	89.9
Length	LengthType	0.0	0.0	100000.0
Depth	WidthType	50.0	0.0	50000.0
ToolPosition	ToolPositionType	left	left/center/right	
MachiningLimits	MachiningLimitType	yes	no	yes

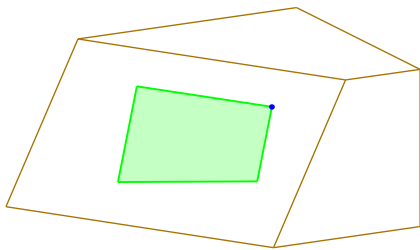

FaceLimitedStart =yes  
 FaceLimitedEnd =yes  
 FaceLimitedBottom =yes

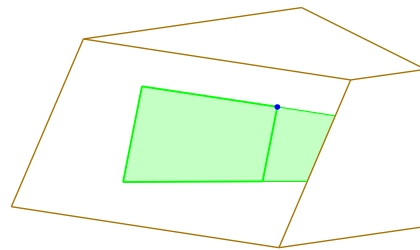

FaceLimitedStart =no  
 FaceLimitedEnd =yes  
 FaceLimitedBottom =yes

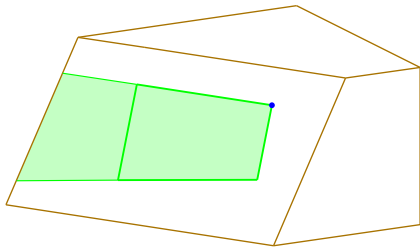

FaceLimitedStart =yes  
 FaceLimitedEnd =no  
 FaceLimitedBottom =yes

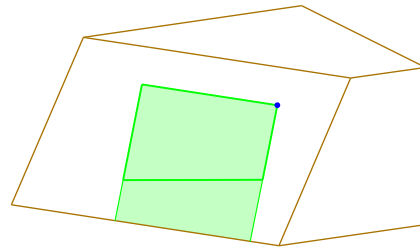

FaceLimitedStart =yes  
 FaceLimitedEnd =yes  
 FaceLimitedBottom =no

Slot

StartDepth = 0

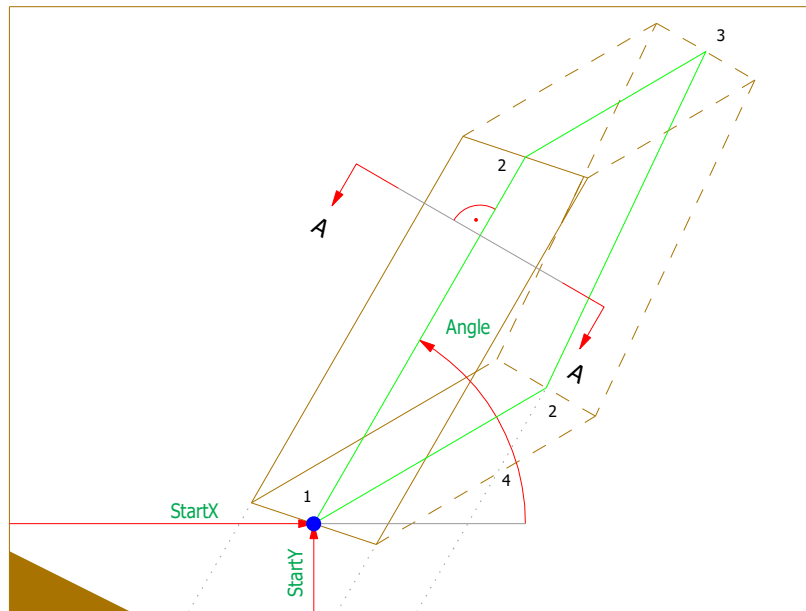
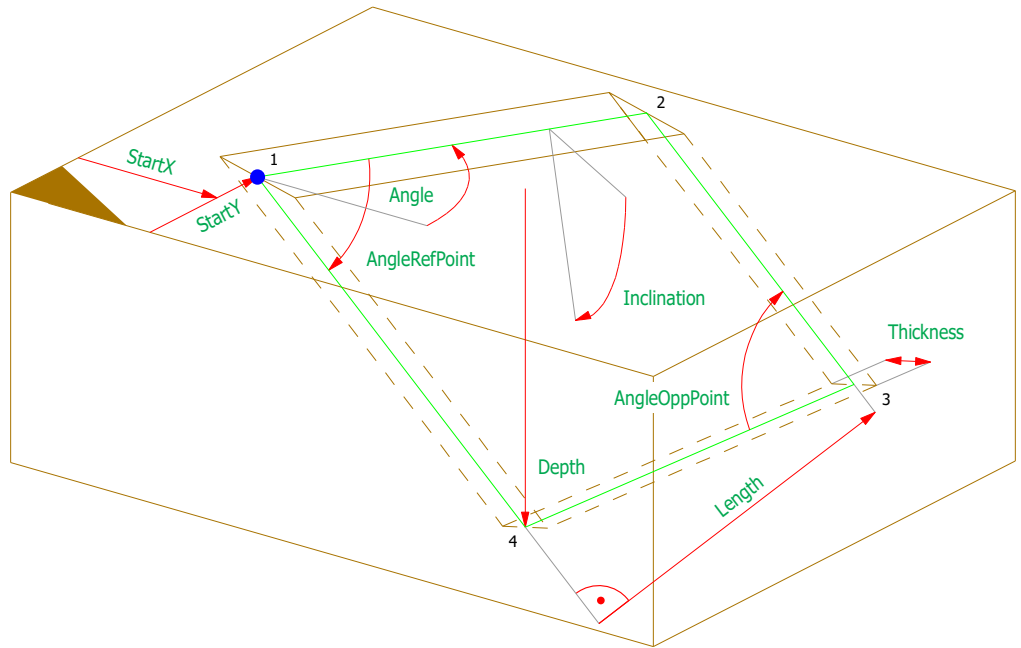

A - A

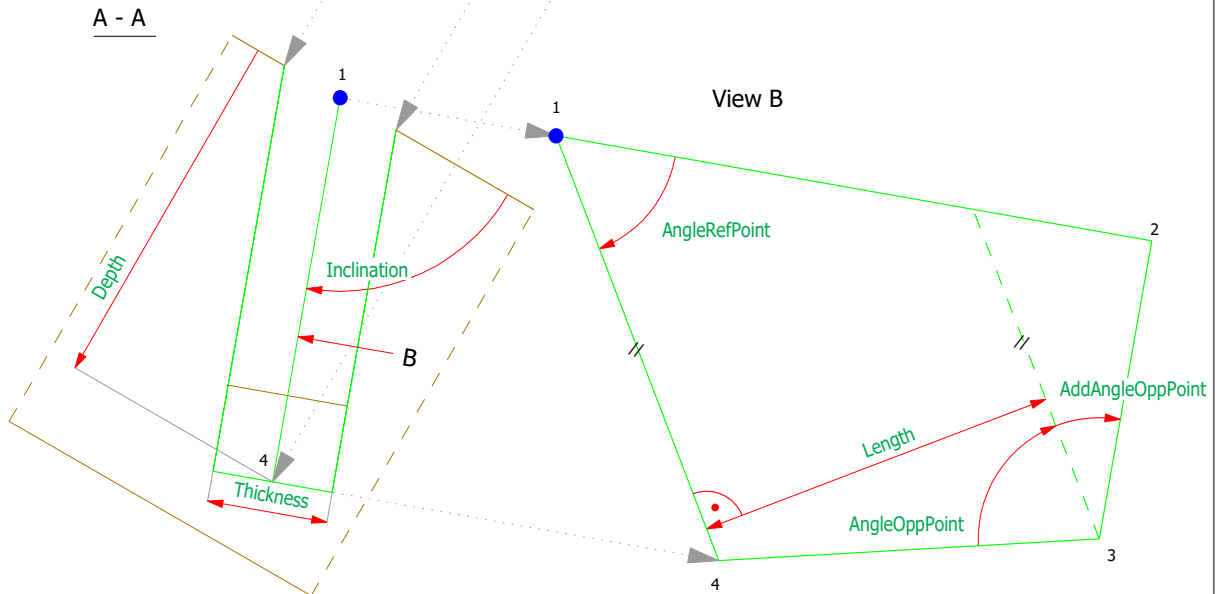

### MachiningLimits

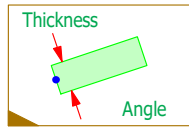

FaceLimitedStart = yes  
 FaceLimitedEnd = yes  
 FaceLimitedFront = yes  
 FaceLimitedBack = yes

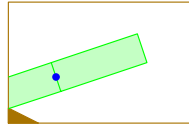

FaceLimitedStart = no

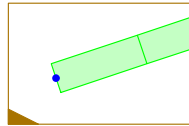

FaceLimitedEnd = no

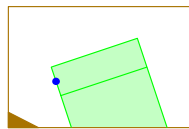

FaceLimitedFront = no

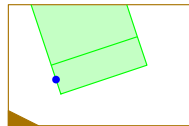

FaceLimitedBack = no

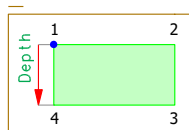

FaceLimitedTop = yes  
 FaceLimitedBottom = yes

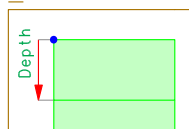

FaceLimitedBottom = no

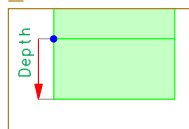

FaceLimitedTop = no

### Other combinations :

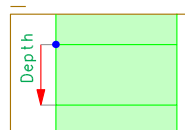
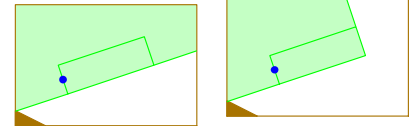
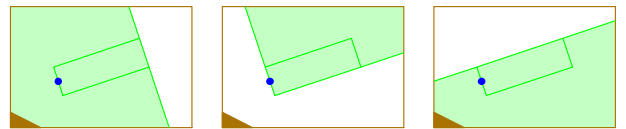
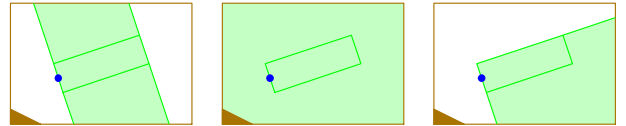
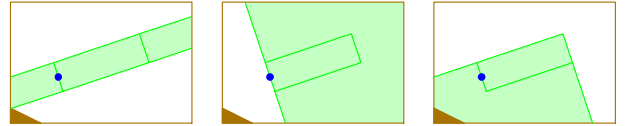

StartDepth <> 0

Orientation = start

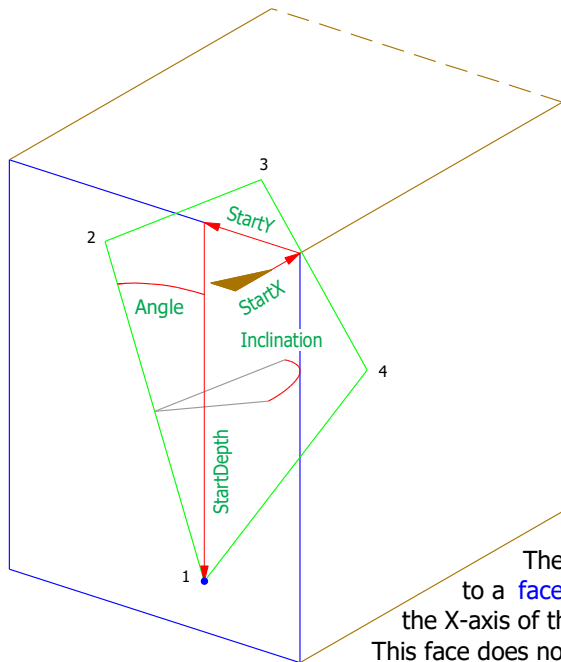

Orientation = end

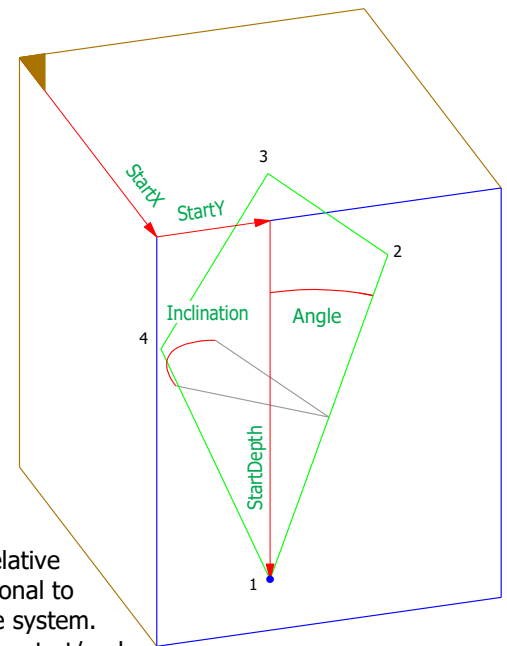

The slot is defined relative to a **face**, which is orthogonal to the X-axis of the part coordinate system. This face does not have to be at the start/end of the beam.

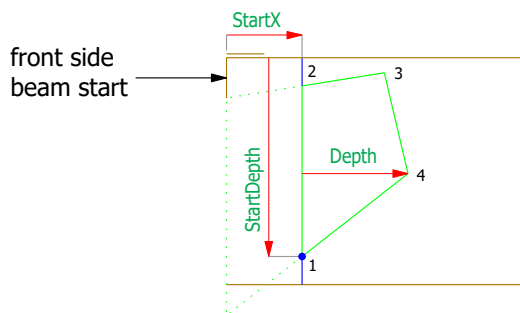

The slot is not limited towards the front sides when StartDepth <> 0.

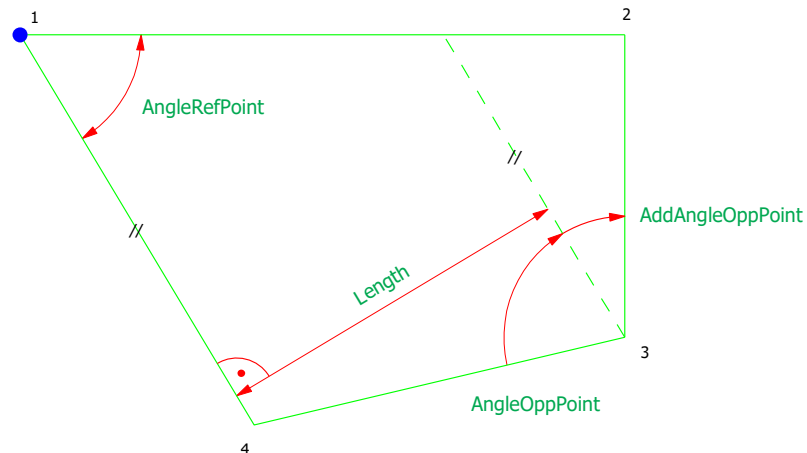
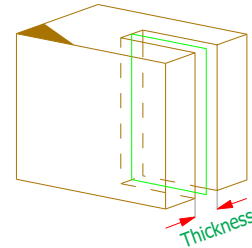
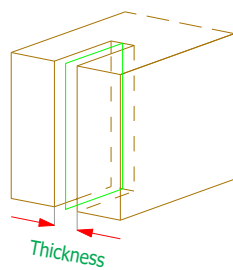
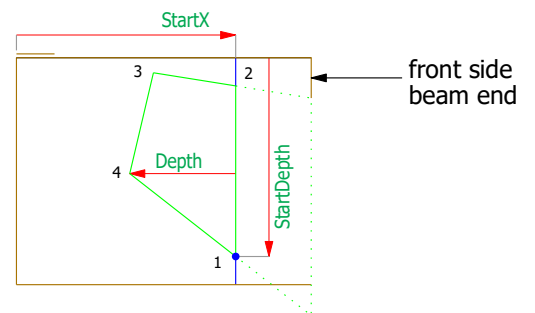

## Parameters Slot

Name	Type	Default	Min	Max
Orientation	OrientationType		start	end
StartX	LengthPosType	0.0	-100000.0	100000.0
StartY	WidthNType	0.0	-50000.0	50000.0
StartDepth	WidthType	0.0	0.0	50000.0
Angle	Inclination2Type	0.0	-90.0	90.0
Inclination	AngleType	90.0	0.1	179.9
Length	LengthType	200.0	0.0	100000.0
Depth	WidthType	10.0	0.0	50000.0
Thickness	WidthType	10.0	0.0	50000.0
AngleRefPoint	AngleType	90.0	0.1	179.9
AngleOppPoint	AngleType	90.0	0.1	179.9
AddAngleOppPoint	AngleNType	0.0	-179.9	179.9
MachiningLimits	MachiningLimitType			

BirdsMouth

Orientation = start

If LeadAngleParallel = yes and LeadInclinationParallel = yes, then these 2 faces are parallel to the front side.

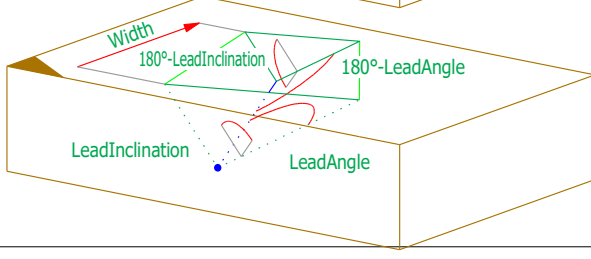
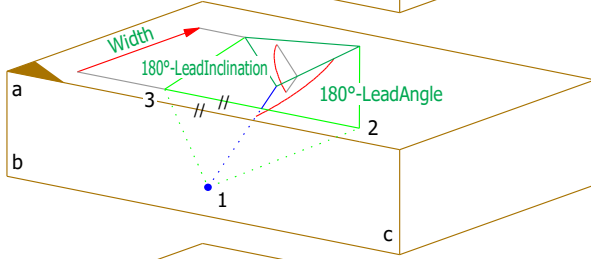
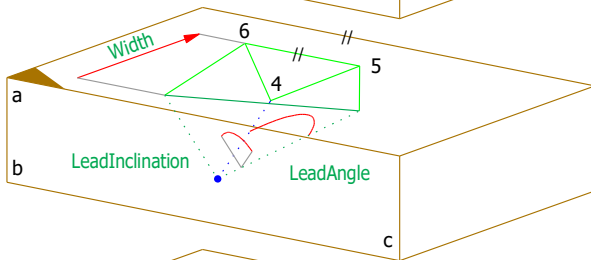
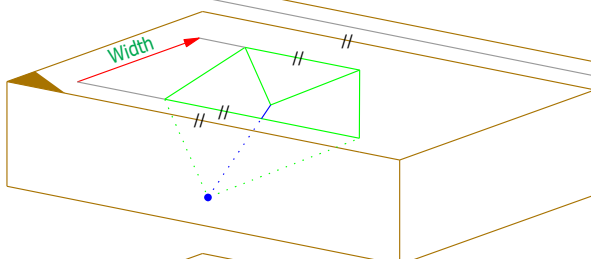
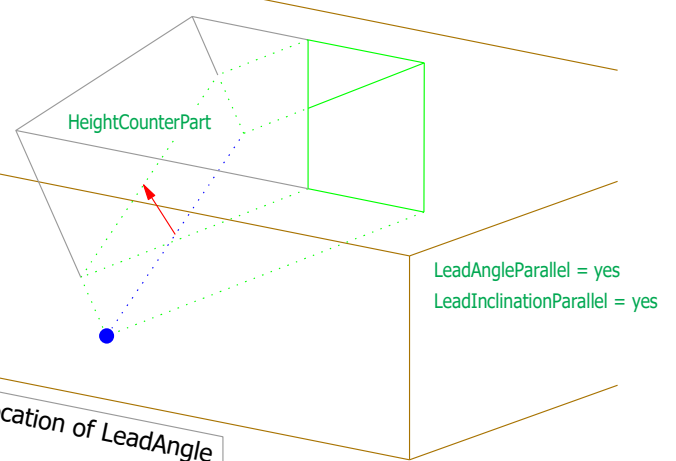
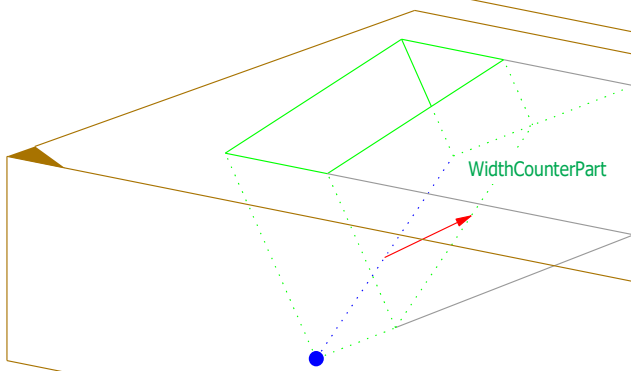
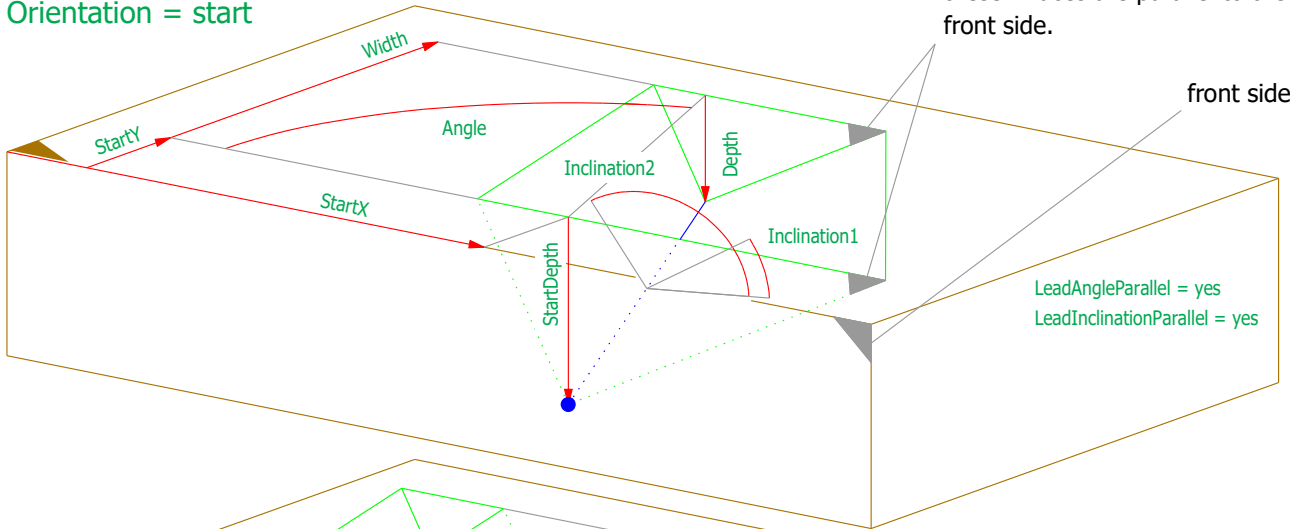

Simple example

Angle = 90  
StartDepth = Depth

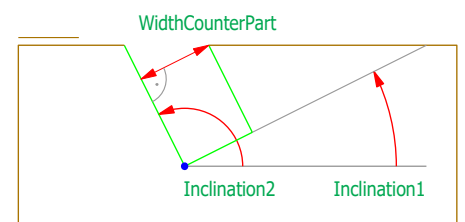
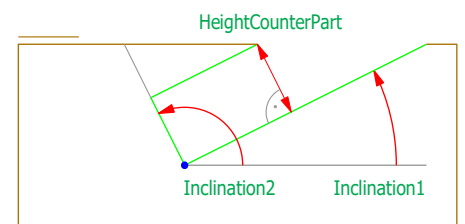
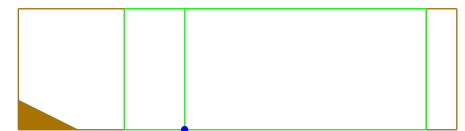



Orientation = end

If LeadAngleParallel = yes and LeadInclinationParallel = yes, then these 2 faces are parallel to the front side.

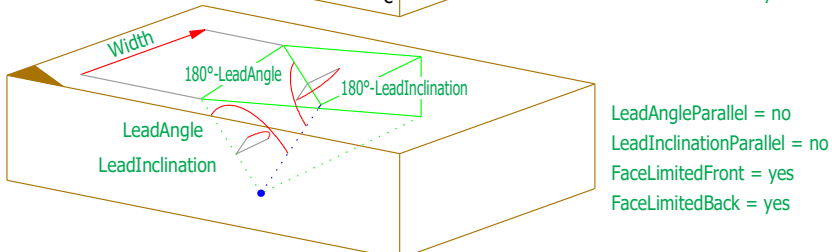
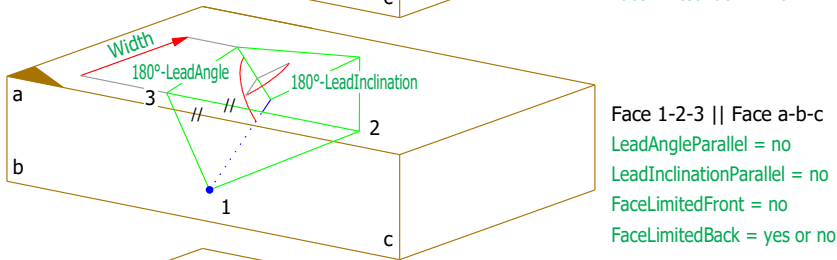
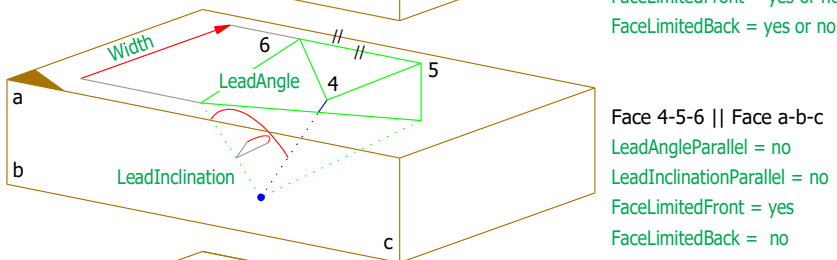
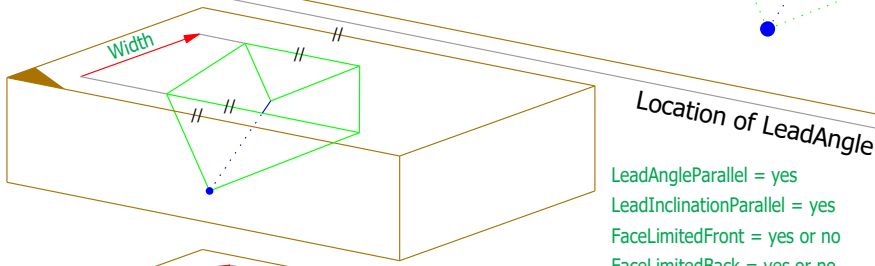
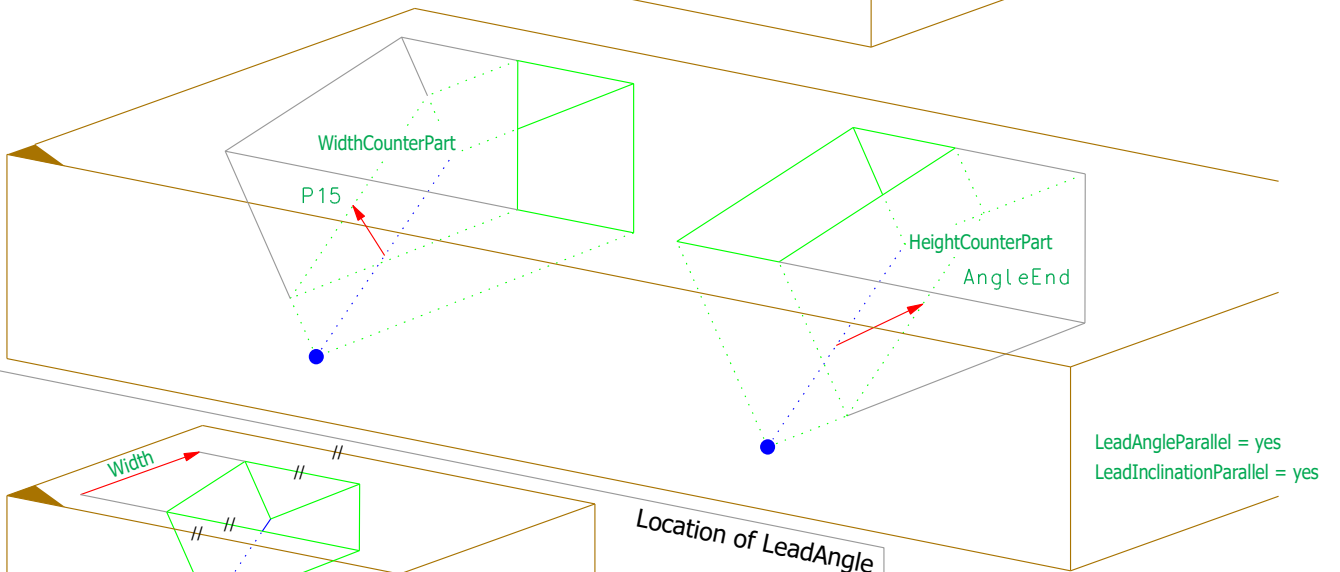
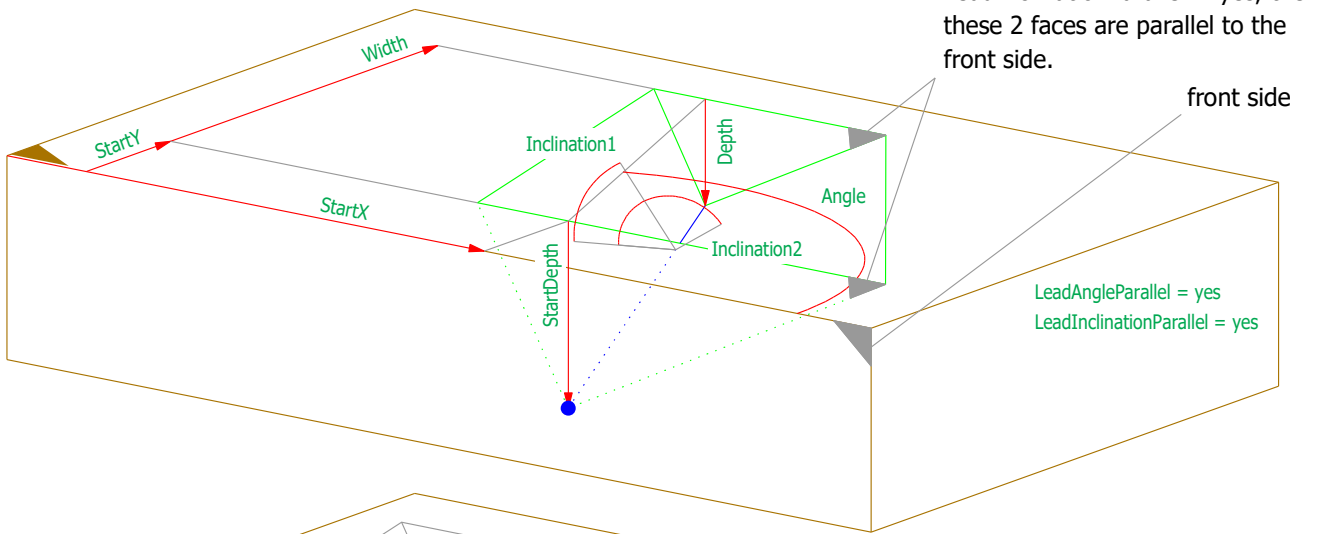

Simple example Angle = 90 StartDepth = Depth

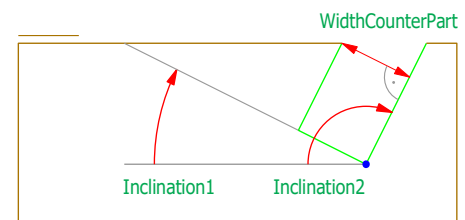
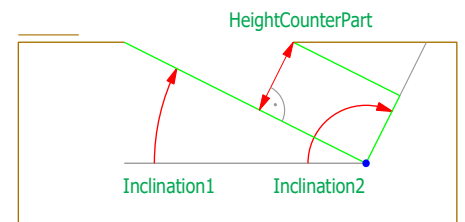
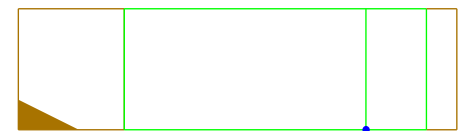

Orientation = start

Another presentation of Inclination1 and Inclination2

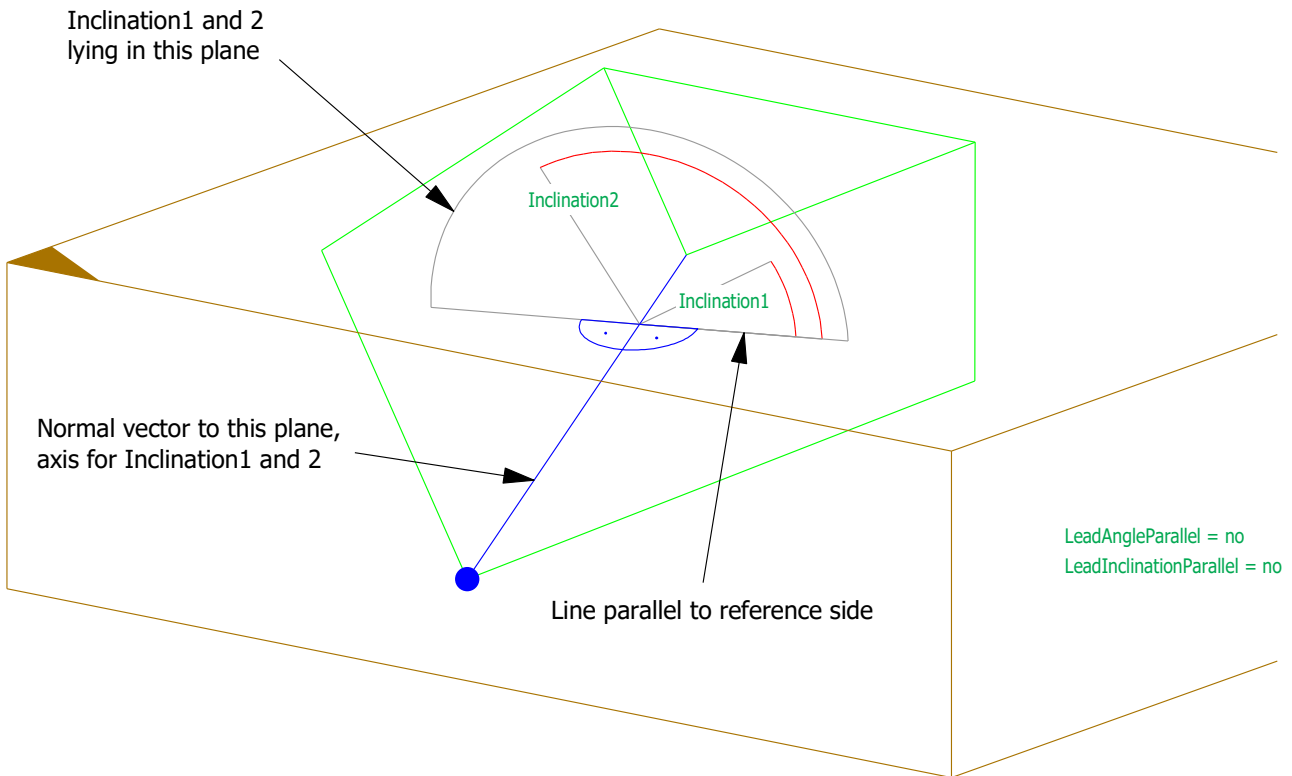

Orientation = end

Another presentation of Inclination1 and Inclination2

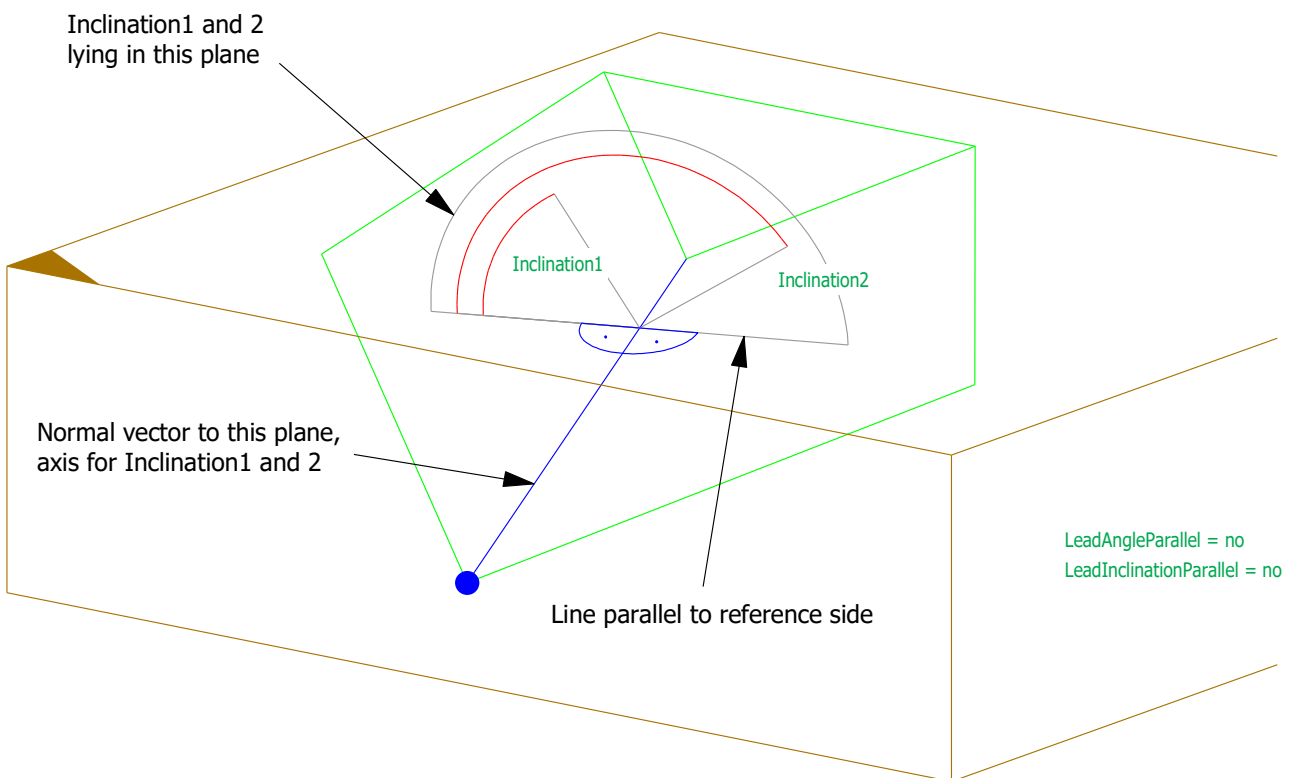

Orientation = start

Another presentation of parameters

View orthogonal to face "Inclination1"

The counterpart enters at the reference edge.

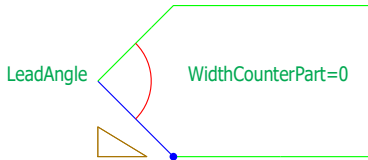

The counterpart enters at opposite of the reference edge.

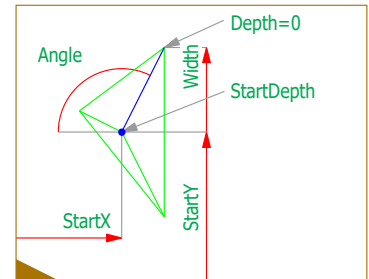
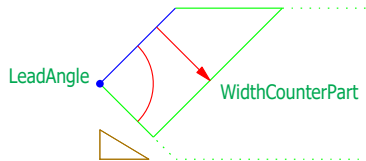
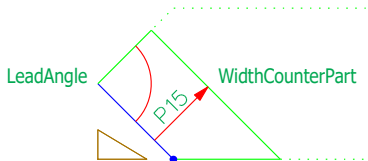
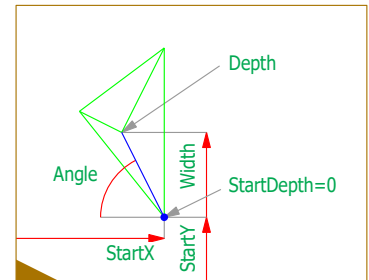
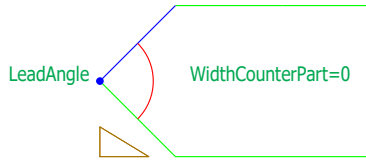

Orientation = end

Another presentation of parameters

View orthogonal to face "Inclination1"

The counterpart enters at the reference edge.

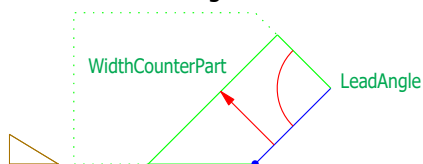

The counterpart enters at opposite of the reference edge.

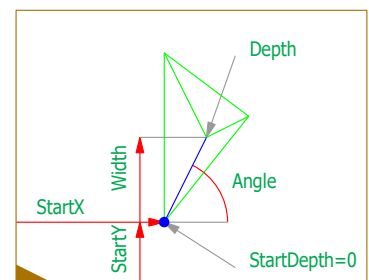
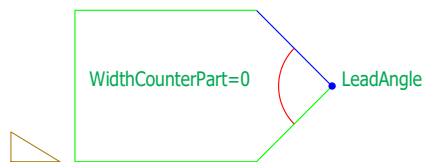
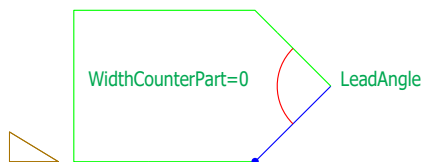
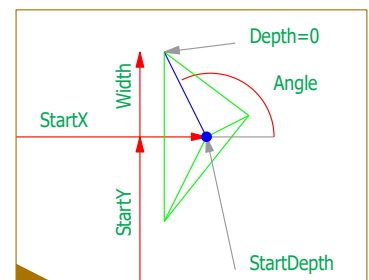
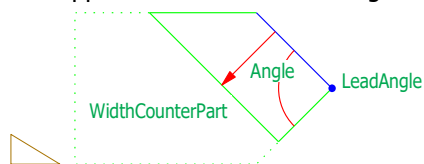

## Parameters BirdsMouth

Name	Type	Default	Min	Max
Orientation	OrientationType		start	end
StartX	LengthPosType	0.0	-100000.0	100000.0
StartY	WidthNType	0.0	-50000.0	50000.0
StartDepth	WidthType	20.0	0.0	50000.0
Angle	AngleType	90.0	0.1	179.9
Inclination1	Angle2Type	45.0	0.0	180.0
Inclination2	Angle2Type	135.0	0.0	180.0
Depth	WidthType	20.0	0.0	50000.0
Width	WidthType	0.0	0.0	50000.0
WidthCounterPartLimited	BooleanType	no	no	yes
WidthCounterPart	WidthType	120.0	0.0	50000.0
HeightCounterPartLimited	BooleanType	no	no	yes
HeightCounterPart	WidthType	120.0	0.0	50000.0
FaceLimitedFront	BooleanType	no	no	yes
FaceLimitedBack	BooleanType	no	no	yes
LeadAngleParallel	BooleanType	yes	no	yes
LeadAngle	AngleType	90.0	0.1	179.9
LeadInclinationParallel	BooleanType	yes	no	yes
LeadInclination	AngleType	90.0	0.1	179.9
RafterNailHole	BooleanType	no	no	yes

### HipValleyRafterNotch

Orientation = start

Orientation = end

hip rafter

hip rafter

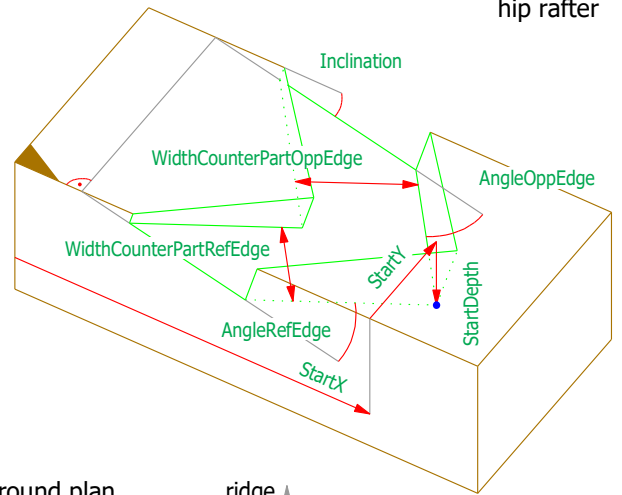
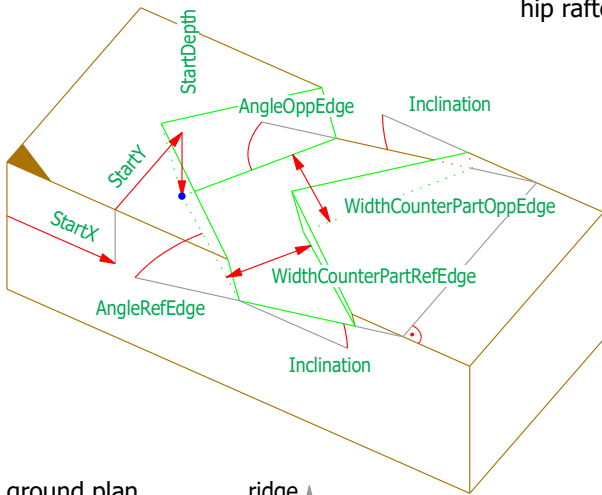

ground plan

ridge ↑

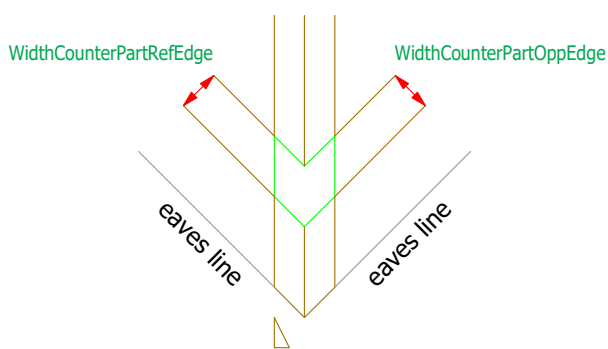

ground plan

ridge ↑

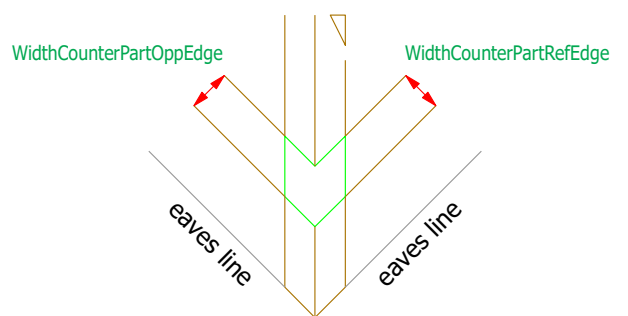

valley rafter

valley rafter

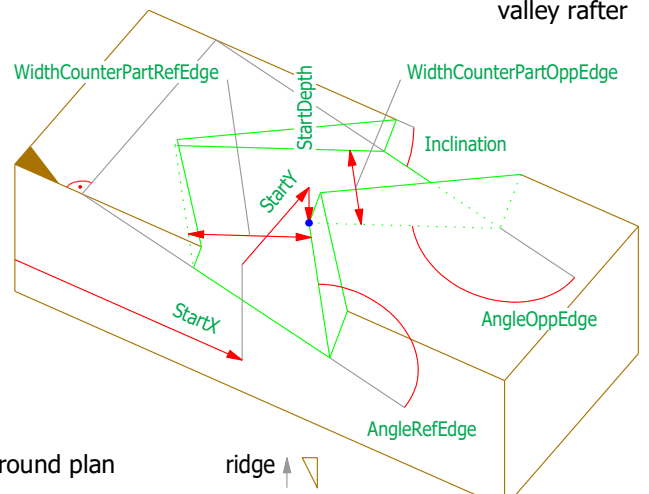
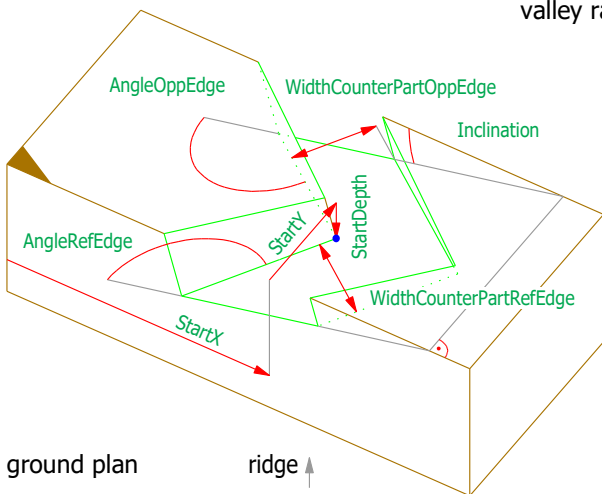

ground plan

ridge ↑

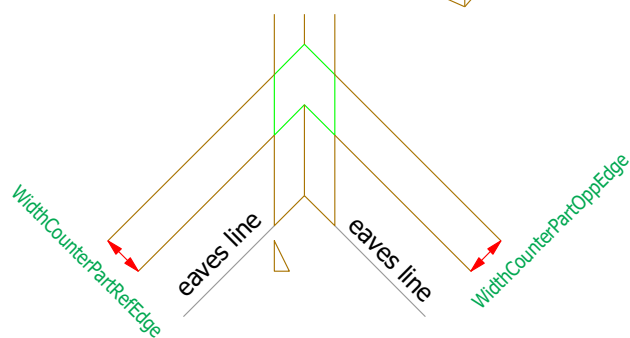

ground plan

ridge ↑

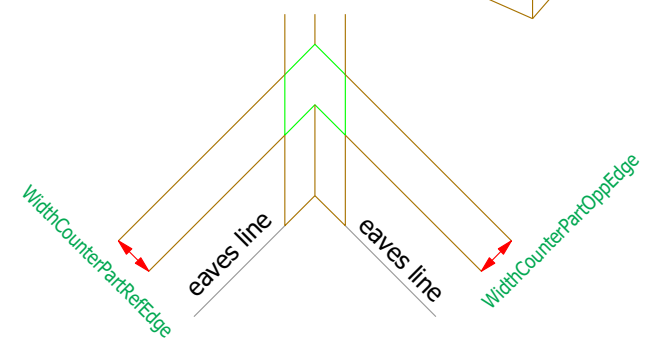

## Parameters HipValleyRafterNotch

Name	Type	Default	Min	Max
Orientation	OrientationType		start	end
StartX	LengthPosType	0.0	-100000	100000
StartY	WidthNType	0.0	-50000	50000
StartDepth	WidthType	20.0	0.0	50000
AngleRefEdge	AngleType	45.0	0.1	179.9
AngleOppEdge	AngleType	45.0	0.1	179.9
Inclination	Angle2Type	30.0	0.0	180.0
WidthCounterPartRefEdgeLimited	BooleanType	no	no	yes
WidthCounterPartRefEdge	WidthType	0.0	0.0	50000
WidthCounterPartOppEdgeLimited	BooleanType	no	no	yes
WidthCounterPartOppEdge	WidthType	0.0	0.0	50000
RafterNailHole	BooleanType	no	no	yes

# Lap

Orientation = start

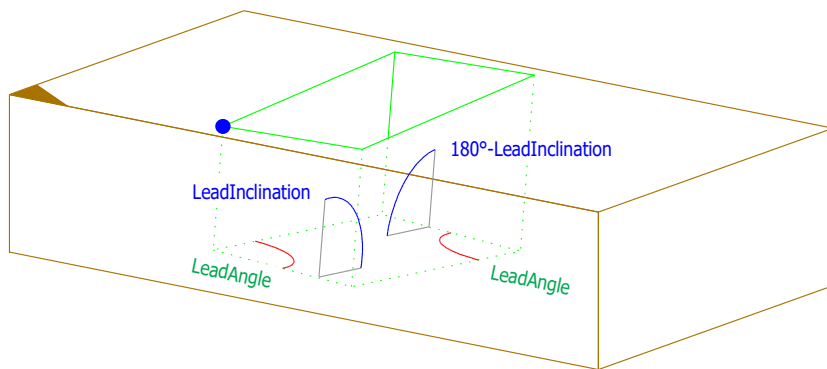
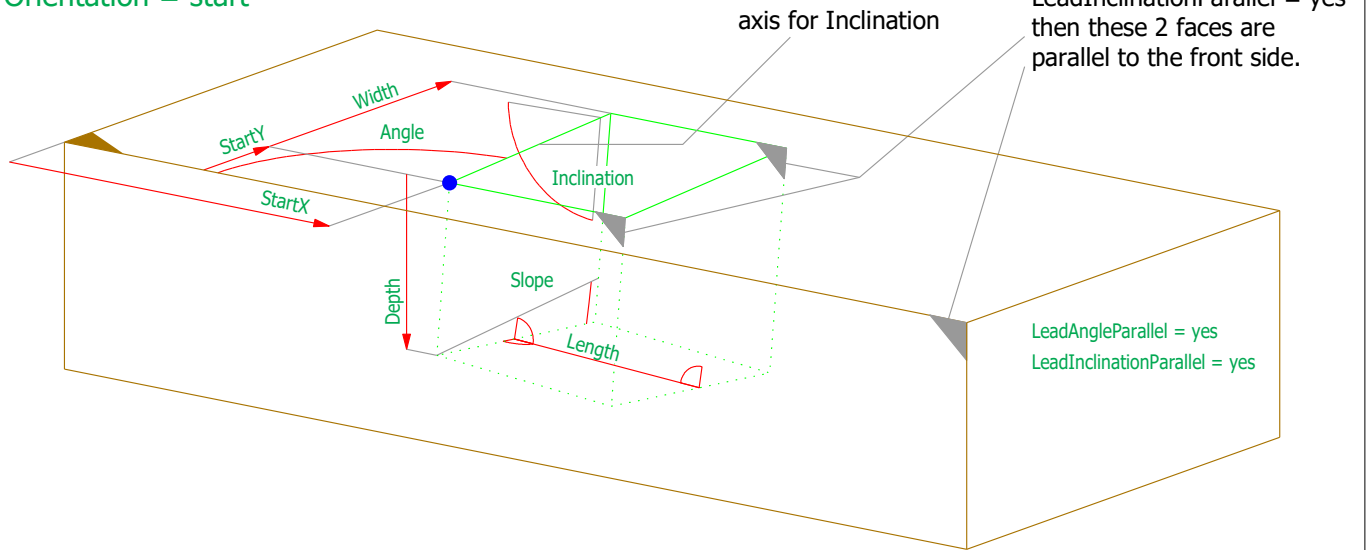

## Location of LeadAngle:

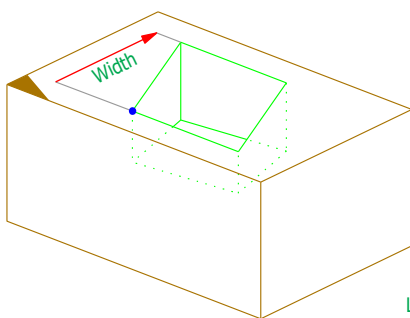

LeadAngleParallel = yes

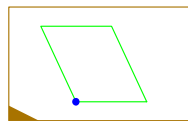

LeadInclinationParallel = yes

LeadAngleParallel and LeadInclinationParallel are yes

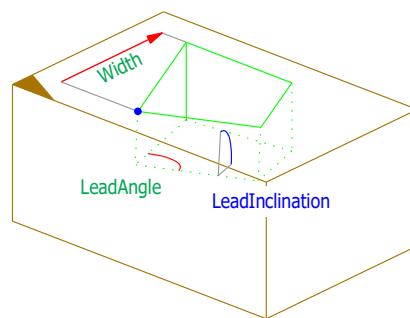

FaceLimitedBack = no

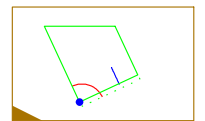

FaceLimitedFront = yes

LeadAngleParallel = no  
LeadInclinationParallel = no

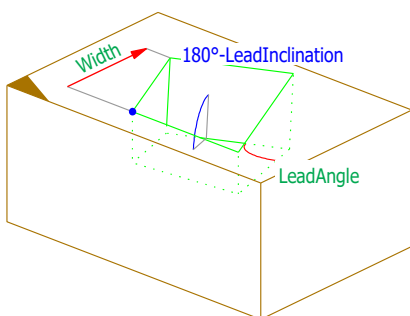

FaceLimitedBack = yes or no

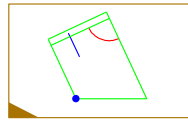

FaceLimitedFront = no

LeadAngleParallel = no  
LeadInclinationParallel = no

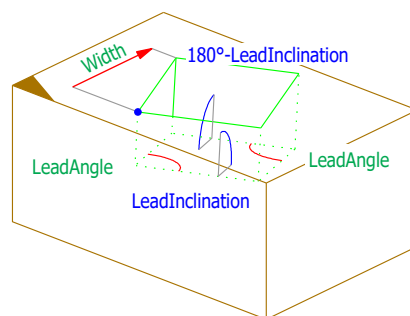

FaceLimitedBack = yes

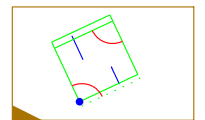

FaceLimitedFront = yes

LeadAngleParallel = no  
LeadInclinationParallel = no

Orientation = end

If LeadAngleParallel = yes and LeadInclinationParallel = yes then these 2 faces are parallel to the front side.

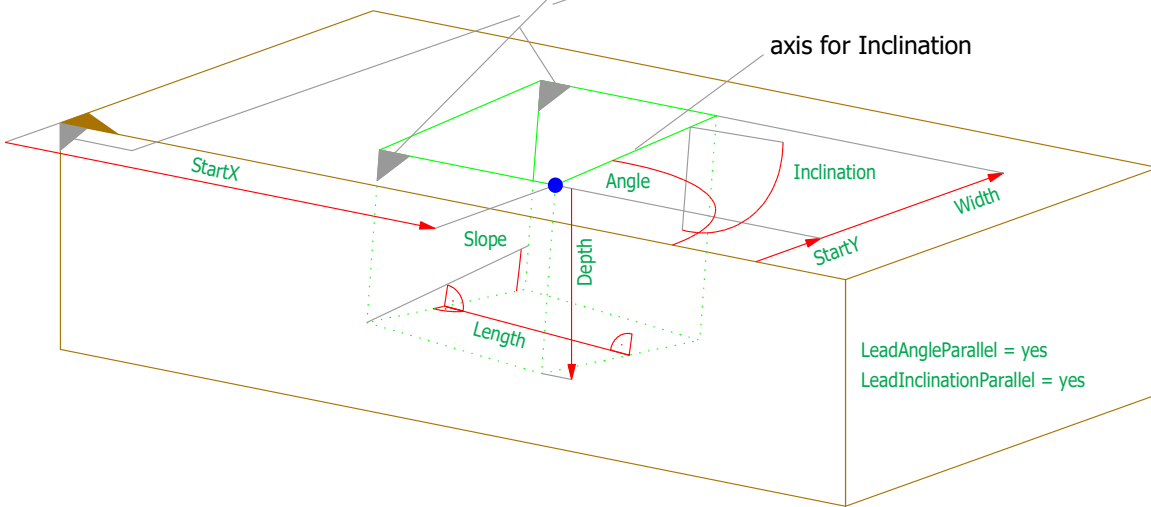

Location of LeadAngle:

LeadAngleParallel = no  
LeadInclinationParallel = no

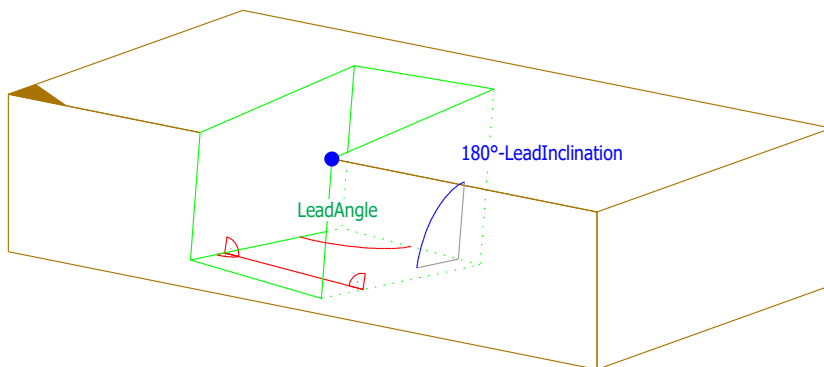

FaceLimitedBack = yes or no  
FaceLimitedFront = no

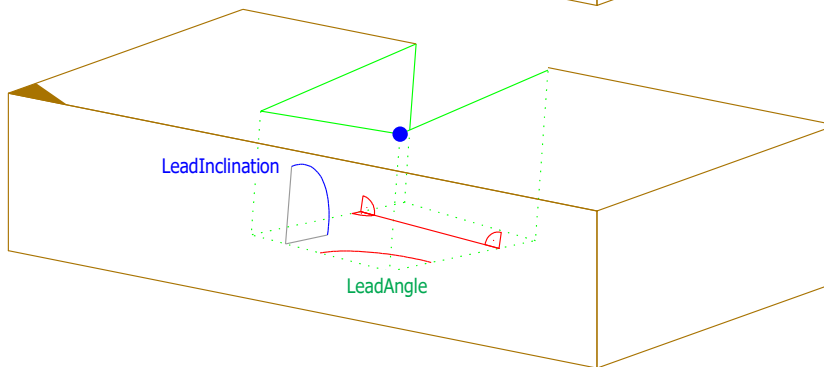

FaceLimitedBack = no  
FaceLimitedFront = yes

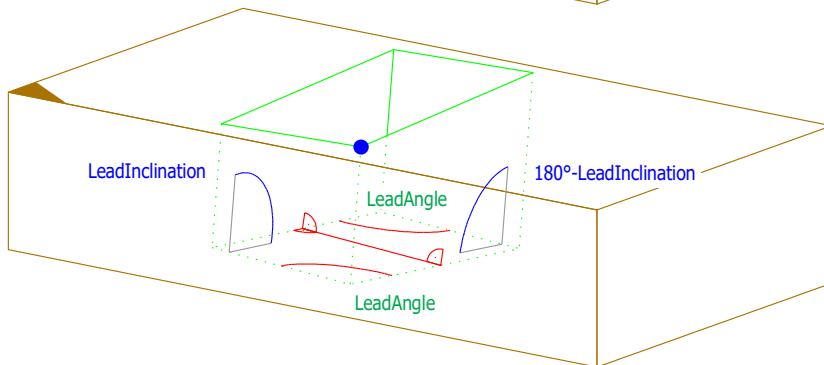

FaceLimitedBack = yes  
FaceLimitedFront = yes



Parameters Lap

Name	Type	Default	Min	Max
Orientation	OrientationType		start	end
StartX	LengthPosType	0.0	-100000	100000
StartY	WidthNTType	0.0	-50000.0	50000
Angle	AngleType	90.0	0.1	179.9
Inclination	AngleType	90.0	0.1	179.9
Slope	InclinationType	0.0	-89.9	89.9
Length	LengthType	200.0	0.0	100000
Width	WidthType	50.0	0.0	50000.0
Depth	WidthNTType	40.0	-50000.0	50000.0
LeadAngleParallel	BooleanType	yes	no	yes
LeadAngle	AngleType	90.0	0.1	179.9
LeadInclinationParallel	BooleanType	yes	no	yes
LeadInclination	AngleType	90.0	0.1	179.9
MachiningLimits	MachiningLimitType			

MachiningLimits

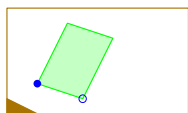
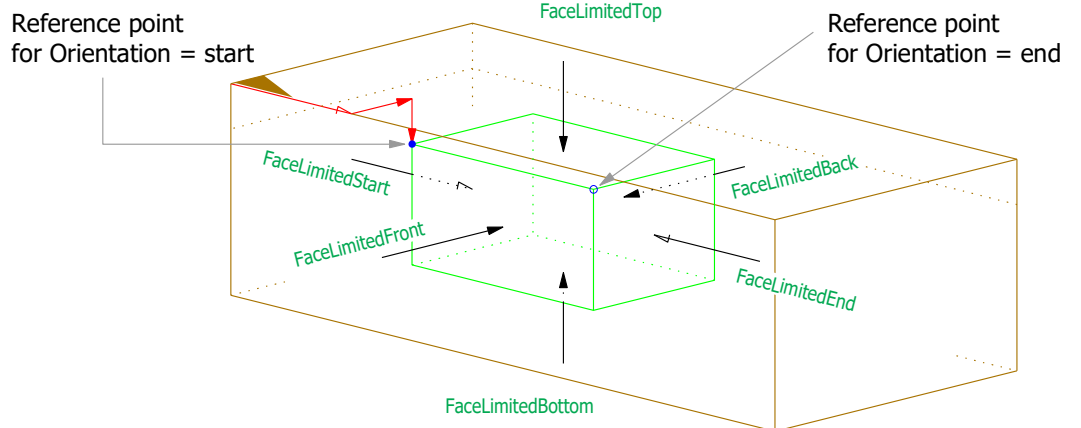

FaceLimitedStart = yes  
 FaceLimitedEnd = yes  
 FaceLimitedFront = yes  
 FaceLimitedBack = yes

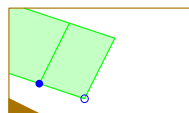

FaceLimitedStart = no  
 FaceLimitedEnd = yes  
 FaceLimitedFront = yes  
 FaceLimitedBack = yes

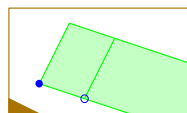

FaceLimitedStart = yes  
 FaceLimitedEnd = no  
 FaceLimitedFront = yes  
 FaceLimitedBack = yes

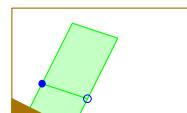

FaceLimitedStart = yes  
 FaceLimitedEnd = yes  
 FaceLimitedFront = no  
 FaceLimitedBack = yes

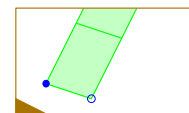

FaceLimitedStart = yes  
 FaceLimitedEnd = yes  
 FaceLimitedFront = yes  
 FaceLimitedBack = no

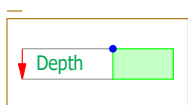

FaceLimitedBottom = yes  
 FaceLimitedTop = yes

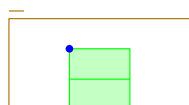

FaceLimitedBottom = no  
 FaceLimitedTop = yes

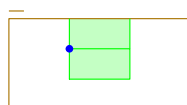

FaceLimitedBottom = yes  
 FaceLimitedTop = no

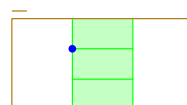

FaceLimitedTop = no  
 FaceLimitedTop = no

Other combinations of MachineLimits

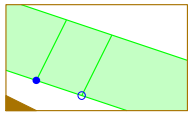

FaceLimitedStart = no  
 FaceLimitedEnd = no  
 FaceLimitedFront = no  
 FaceLimitedBack = yes

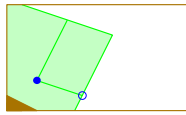

FaceLimitedStart = no  
 FaceLimitedEnd = yes  
 FaceLimitedFront = no  
 FaceLimitedBack = yes

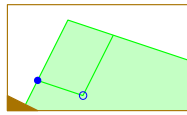

FaceLimitedStart = yes  
 FaceLimitedEnd = no  
 FaceLimitedFront = no  
 FaceLimitedBack = yes

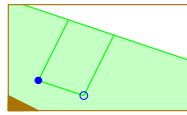

FaceLimitedStart = no  
 FaceLimitedEnd = no  
 FaceLimitedFront = no  
 FaceLimitedBack = yes

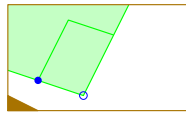

FaceLimitedStart = no  
 FaceLimitedEnd = yes  
 FaceLimitedFront = yes  
 FaceLimitedBack = no

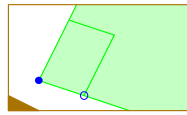

FaceLimitedStart = yes  
 FaceLimitedEnd = no  
 FaceLimitedFront = yes  
 FaceLimitedBack = no

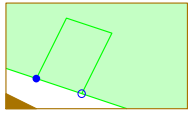

FaceLimitedStart = no  
 FaceLimitedEnd = no  
 FaceLimitedFront = yes  
 FaceLimitedBack = no

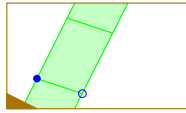

FaceLimitedStart = yes  
 FaceLimitedEnd = yes  
 FaceLimitedFront = no  
 FaceLimitedBack = no

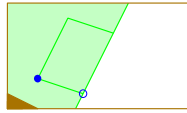

FaceLimitedStart = no  
 FaceLimitedEnd = yes  
 FaceLimitedFront = no  
 FaceLimitedBack = no

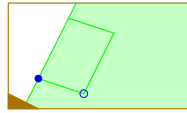

FaceLimitedStart = yes  
 FaceLimitedEnd = no  
 FaceLimitedFront = no  
 FaceLimitedBack = no

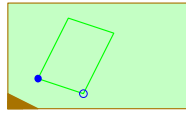

FaceLimitedStart = no  
 FaceLimitedEnd = no  
 FaceLimitedFront = no  
 FaceLimitedBack = no

LeadAngle:

LeadAngleParallel = yes  
 LeadInclinationParallel = yes

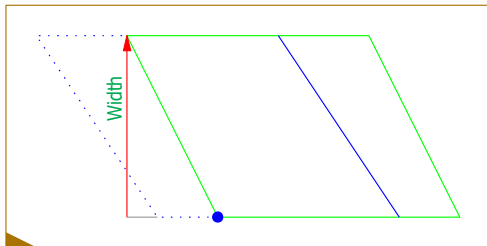

LeadAngleParallel = yes  
 LeadInclinationParallel = no

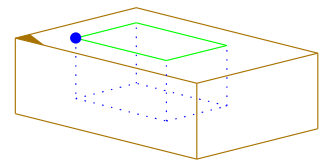
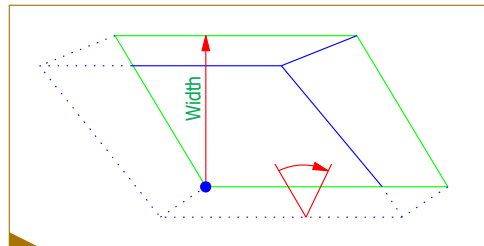

LeadAngleParallel = no  
 LeadInclinationParallel = yes

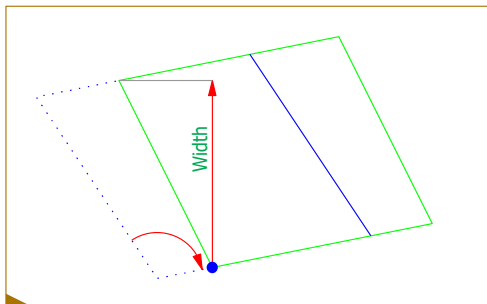

LeadAngleParallel = no  
 LeadInclinationParallel = no

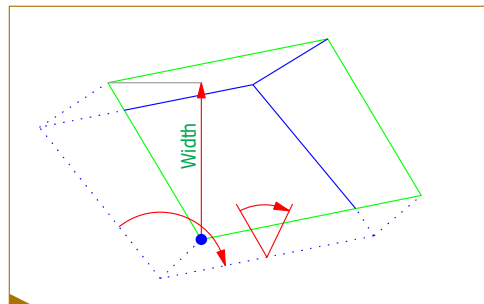

LogHouseHalfLap

Orientation = start

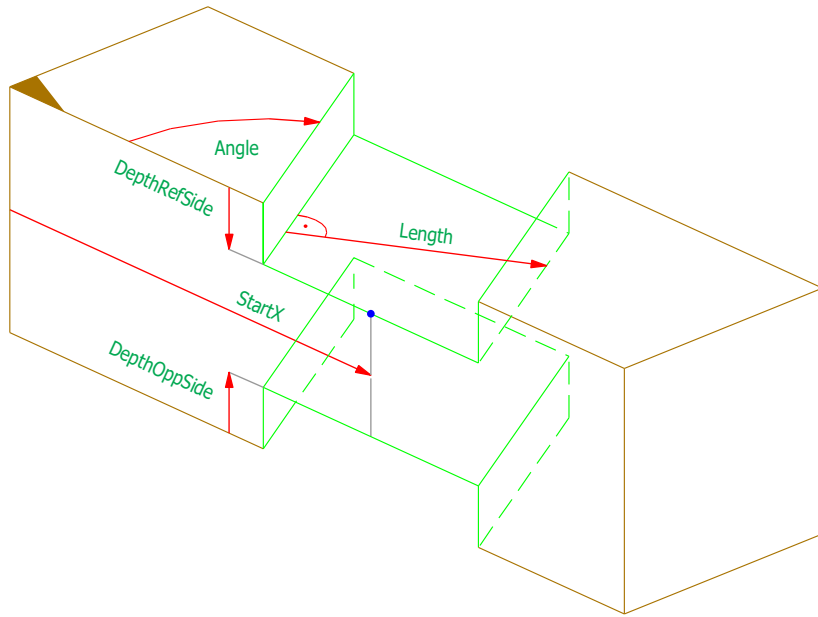

Orientation = end

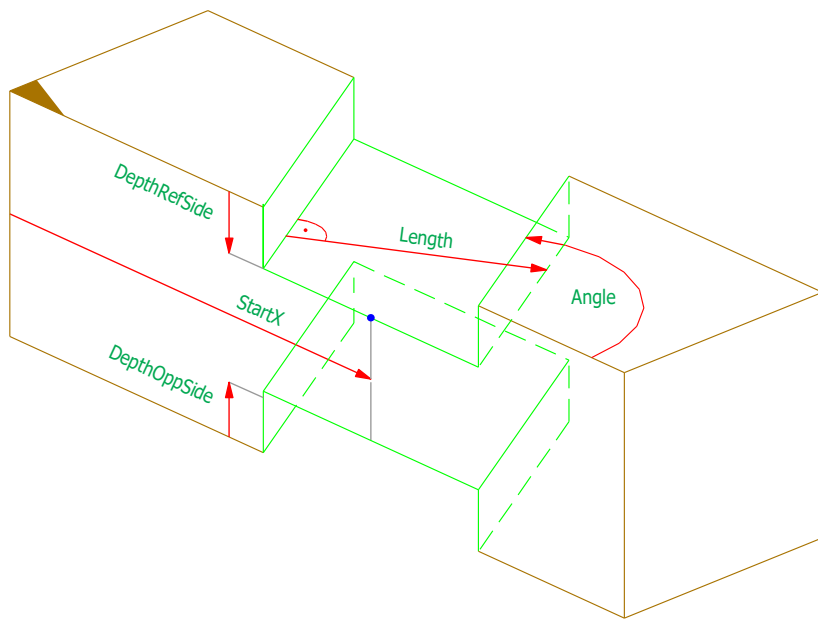

## Parameters LogHouseHalfLap

Name	Type	Default	Min	Max
Orientation	OrientationType		start	end
StartX	LengthPosType	0.0	-100000.0	100000.0
Angle	AngleType	90.0	0.1	179.9
Length	WidthType	120.0	0.0	50000.0
DepthRefSide	WidthType	20.0	0.0	50000.0
DepthOppSide	WidthType	20.0	0.0	50000.0

FrenchRidgeLap

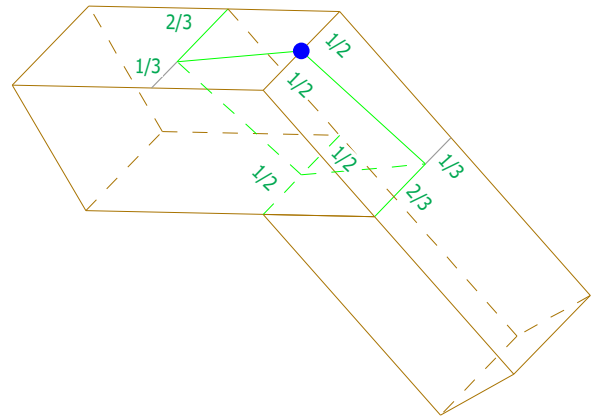
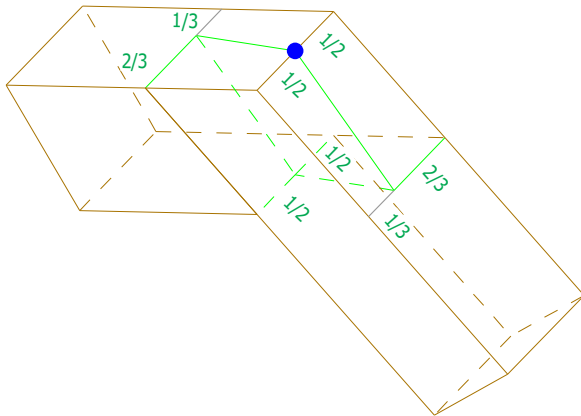

The length of the lap is equal to the width of reference side.

Orientation = start

RefPosition = refedge

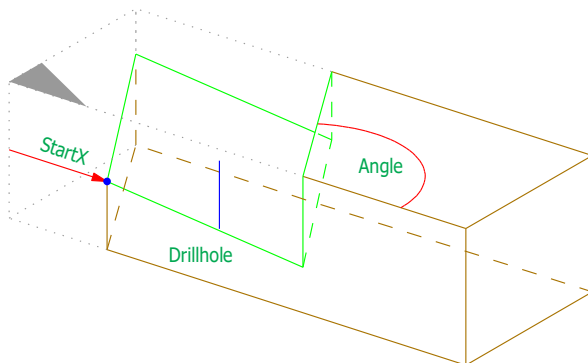

Orientation = start

RefPosition = oppedge

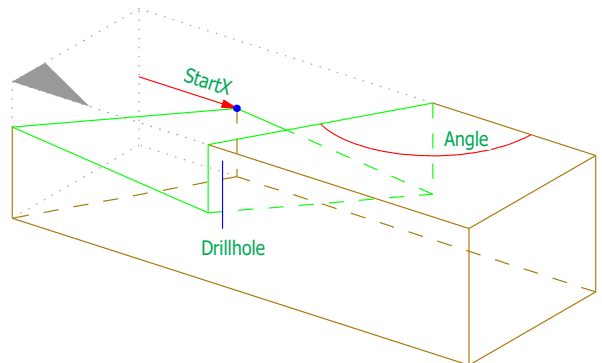

Orientation = end

RefPosition = oppedge

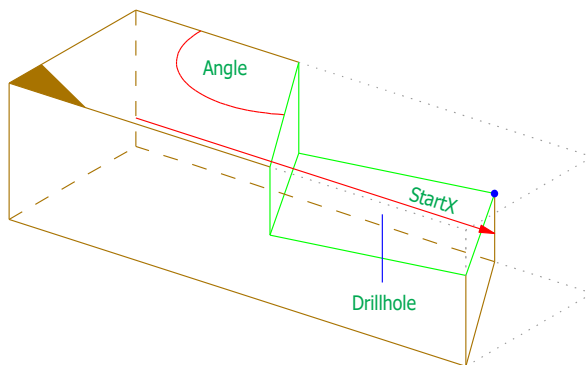

Orientation = end

RefPosition = refedge

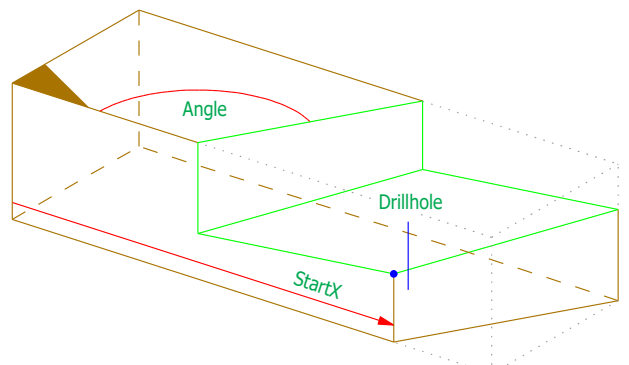

## Parameters FrenchRidgeLap

Name	Type	Default	Min	Max
Orientation	OrientationType		start	end
StartX	LengthPosType	0.0	-100000.0	100000.0
Angle	AngleType	90.0	0.1	179.9
RefPosition	EdgePositionType	refedge	refedge	oppedge
Drillhole	BooleanType	no	no	yes
DrillholeDiam	LengthSType	0.0	0.0	1000.0

This processing trims the part, even it is on a ReferencePlane

Examples:



### Chamfer

#### Orientation = start

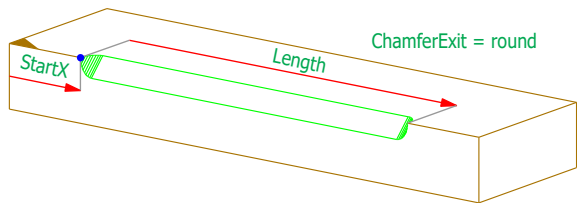
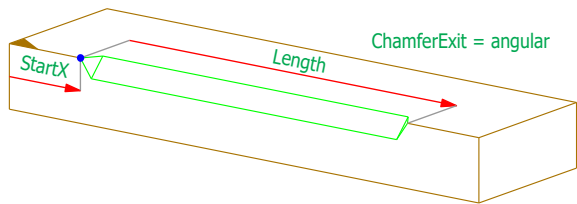
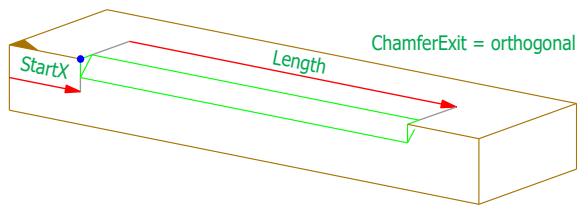

#### Orientation = end

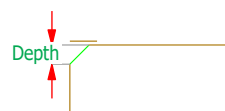
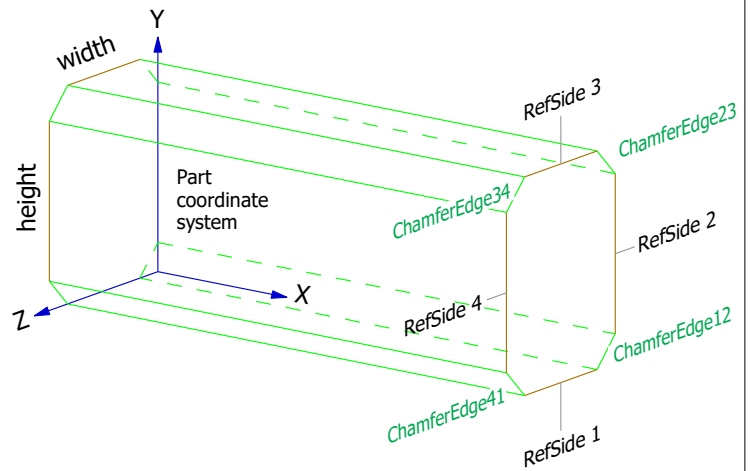
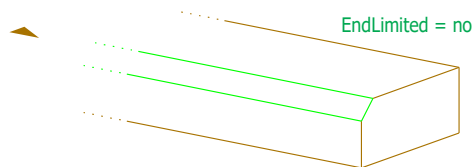
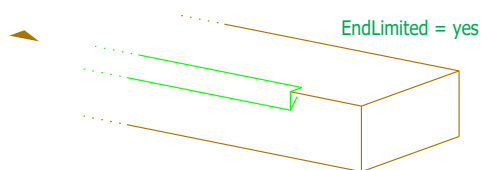
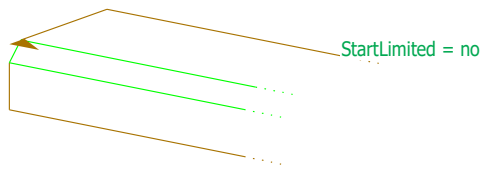
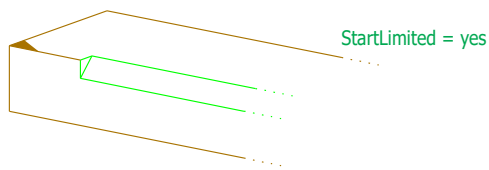
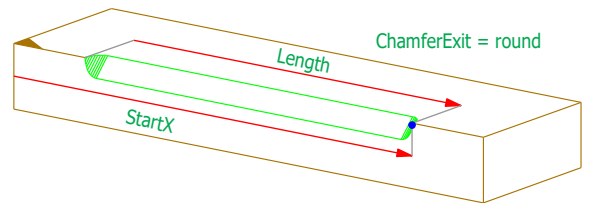
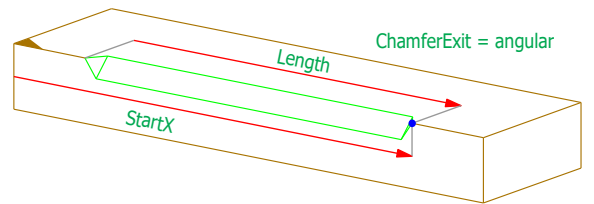
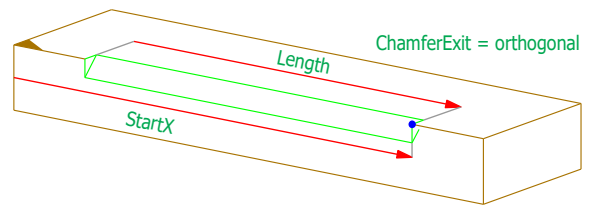

## Parameters Chamfer

Name	Type	Default	Min	Max
StartX	LengthPosType	0.0	-100000.0	100000.0
StartLimited	BooleanType	no	no	yes
EndLimited	BooleanType	no	no	yes
Length	LengthType	0.0	0.0	100000.0
Depth	double	1.0	0.0	100.0
ChamferEdge12	BooleanType	yes	no	yes
ChamferEdge23	BooleanType	yes	no	yes
ChamferEdge34	BooleanType	yes	no	yes
ChamferEdge41	BooleanType	yes	no	yes
ChamferExit	ChamferExitType	orthogonal	orthogonal/angular/round	



### LogHouseJoint

LapPosition = symmetric

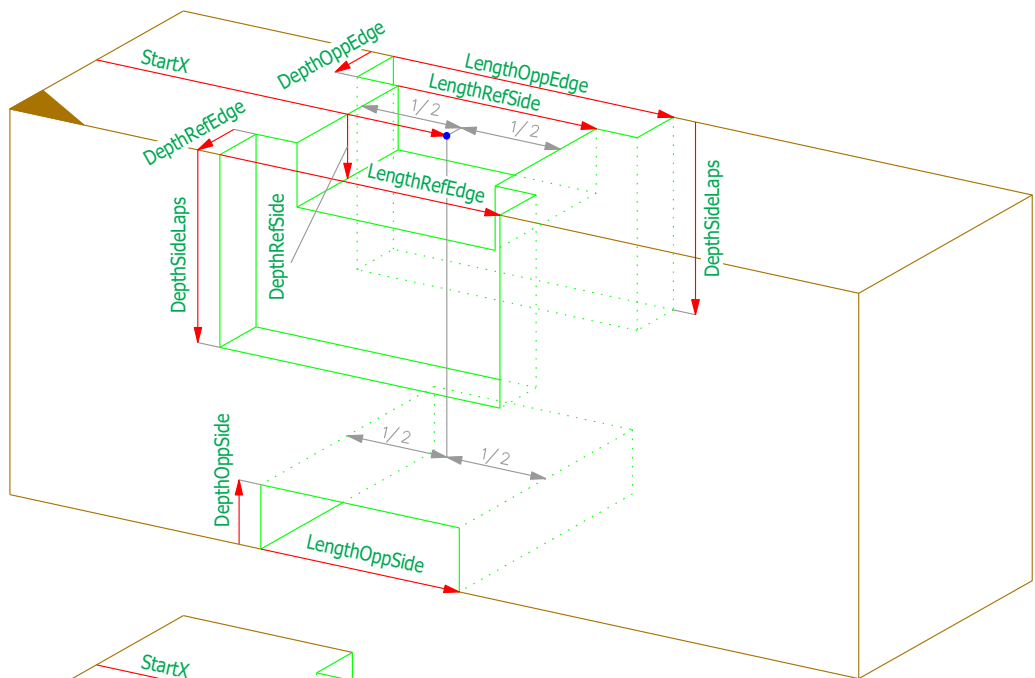

LapPosition = forward

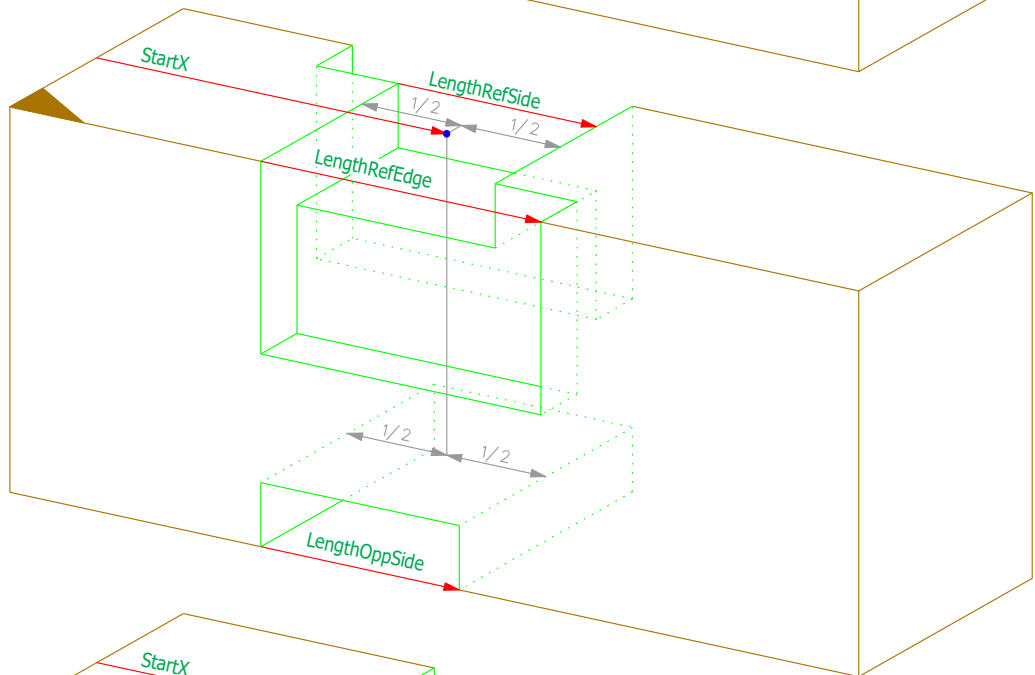

LapPosition = backward

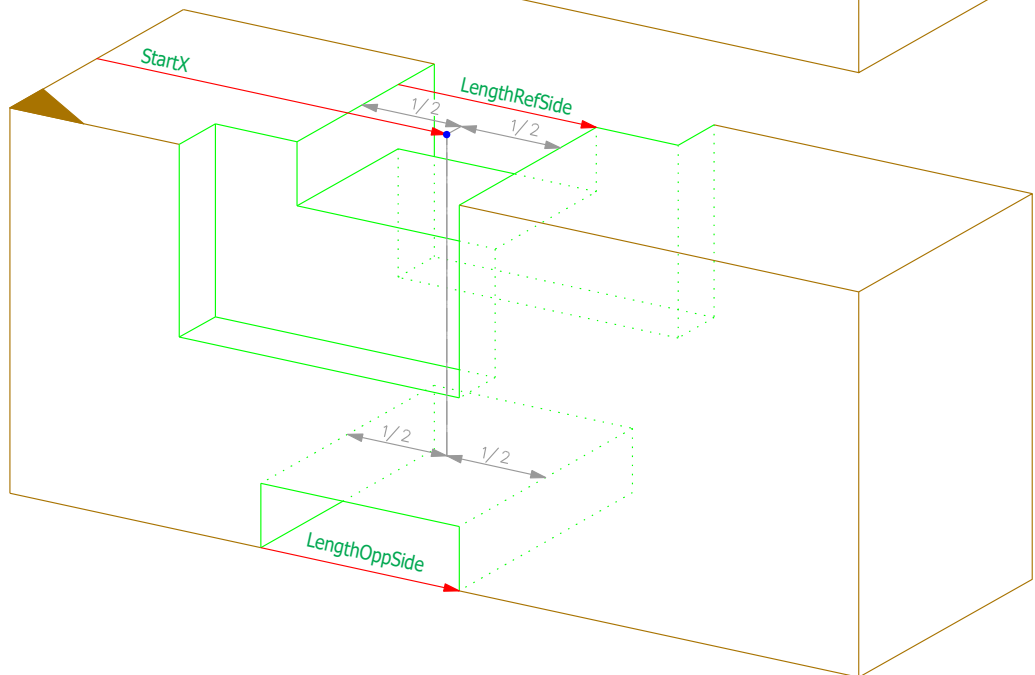

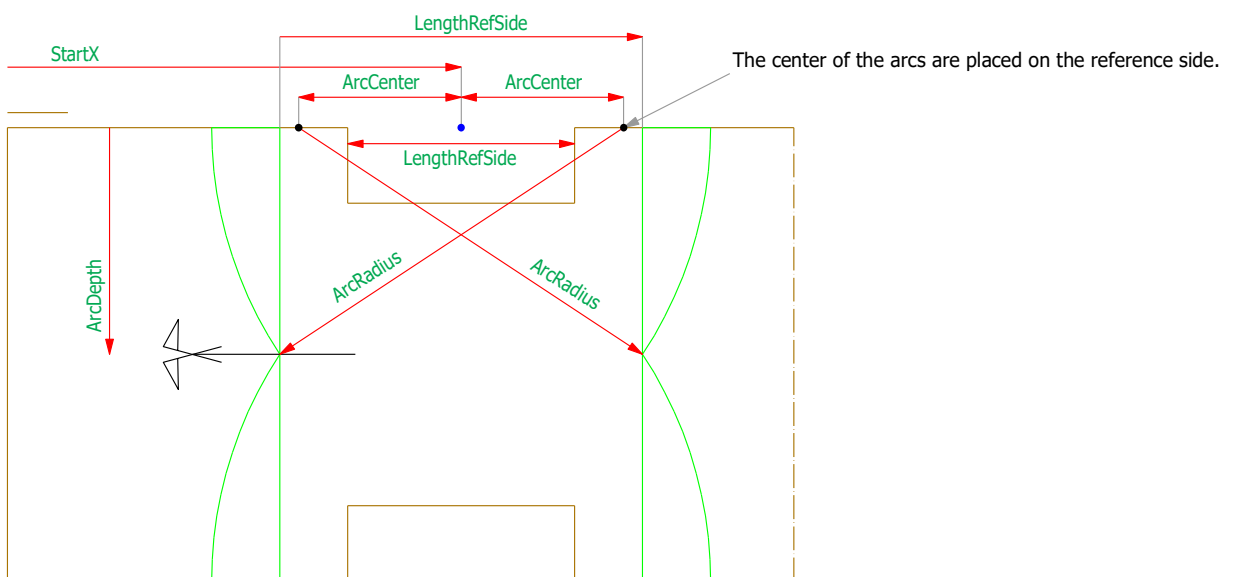
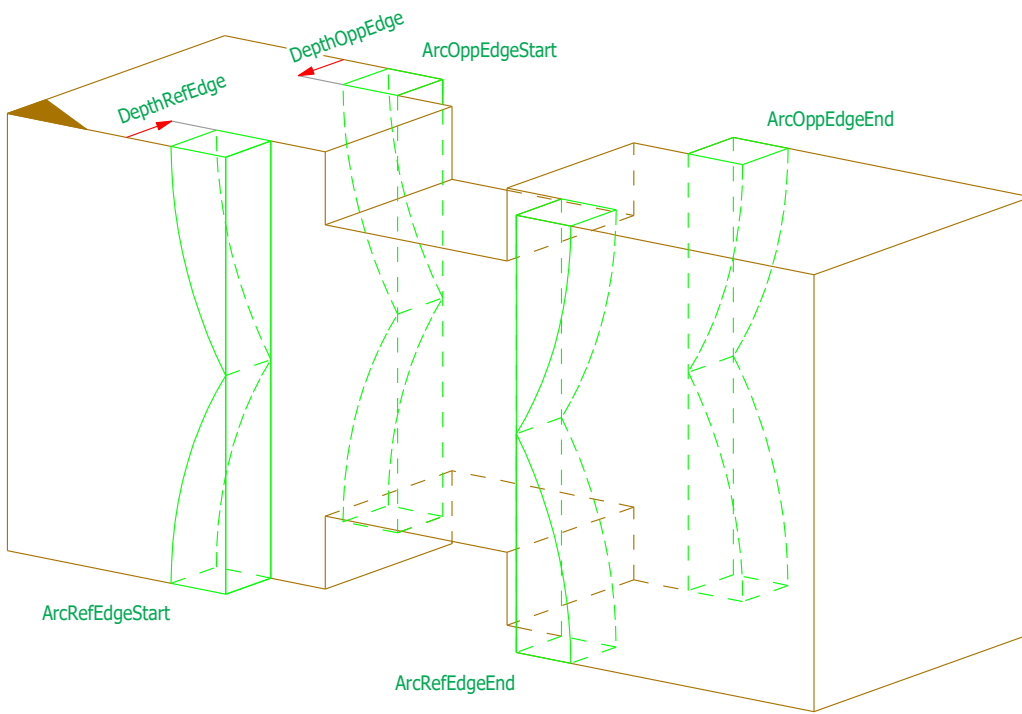
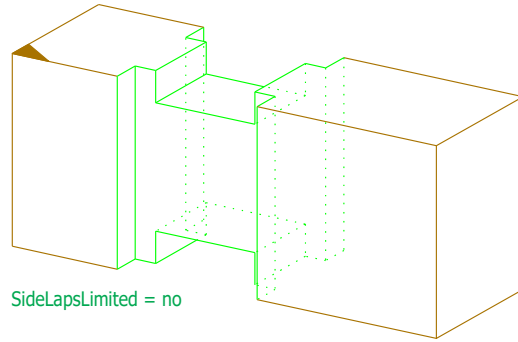
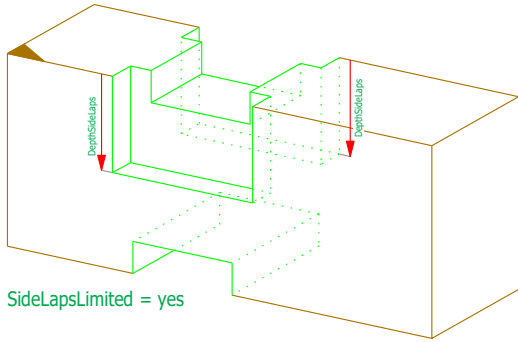

## Parameters LogHouseJoint

Name	Type	Default	Min	Max
StartX	LengthPosType	0.0	-100000.0	100000.0
SideLapsLimited	BooleanType	no	no	yes
DepthSideLaps	WidthType		0.0	50000.0
LapPosition	LogLapPositionType	symmetric	symmetric/forward/backward	
LengthRefSide	WidthType	100.0	0.0	50000.0
DepthRefSide	WidthType	10.0	0.0	50000.0
LengthOppSide	WidthType	100.0	0.0	50000.0
DepthOppSide	WidthType	10.0	0.0	50000.0
LengthRefEdge	WidthType	100.0	0.0	50000.0
DepthRefEdge	WidthType	10.0	0.0	50000.0
LengthOppEdge	WidthType	100.0	0.0	50000.0
DepthOppEdge	WidthType	10.0	0.0	50000.0
Drillhole	BooleanType	no	no	yes
ArcRefEdgeStart	BooleanType	no	no	yes
ArcRefEdgeEnd	BooleanType	no	no	yes
ArcOppEdgeStart	BooleanType	no	no	yes
ArcOppEdgeEnd	BooleanType	no	no	yes
ArcRadius	WidthType	120.0	0.0	50000.0
ArcDepth	WidthNTType	60.0	-50000.0	50000.0
ArcCenter	WidthType	120.0	0.0	50000.0

### LogHouseFront

Orientation = start

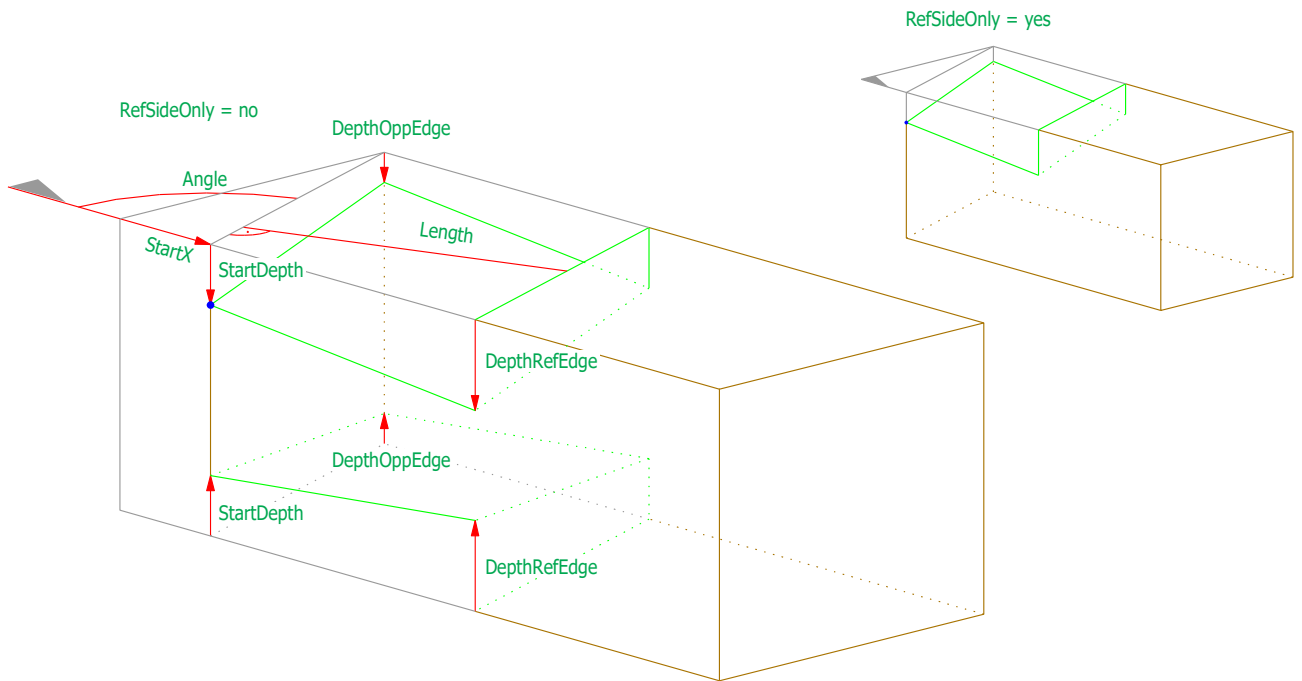

Orientation = end

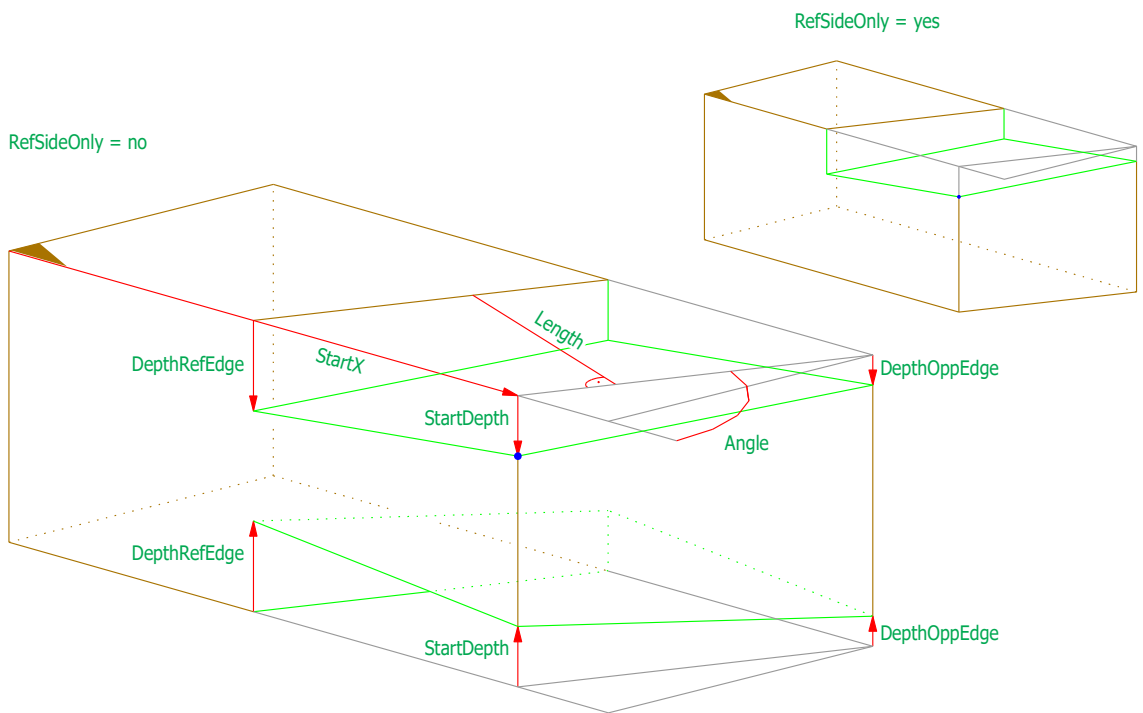

## Parameters LogHouseFront

Name	Type	Default	Min	Max
Orientation	OrientationType		start	end
StartX	LengthPosType	0.0	-100000.0	100000.0
StartDepth	WidthType	20.0	0.0	50000.0
Angle	AngleType	90.0	0.1	179.9
Length	WidthType	120.0	0.0	50000.0
DepthRefEdge	WidthType	20.0	0.0	50000.0
DepthOppEdge	WidthType	20.0	0.0	50000.0
RefSideOnly	BooleanType	no	no	yes

This processing trims the part, even it is on a ReferencePlane

Examples:



Pocket

here: TiltStartSide = 90  
 TiltEndSide = 90  
 TiltRefSide = 90  
 TiltOppSide = 90

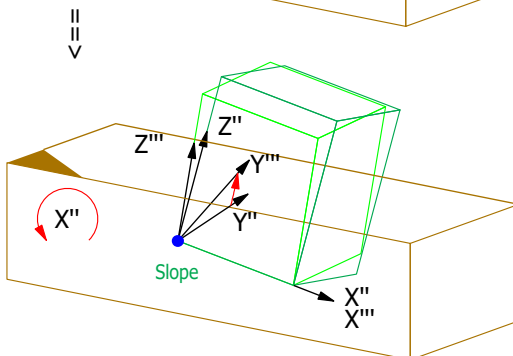
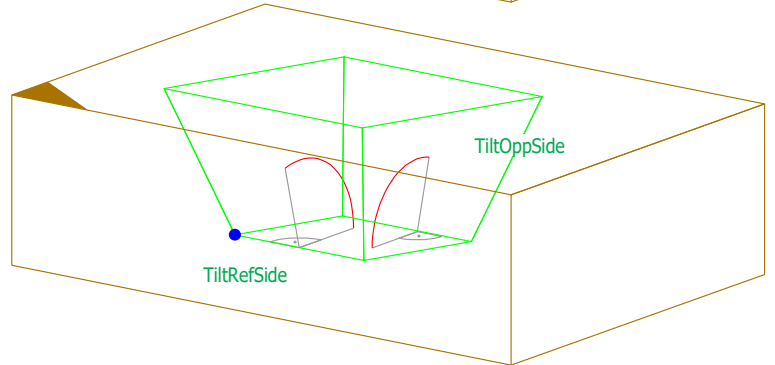
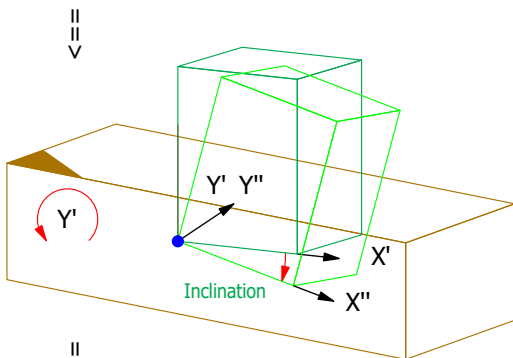
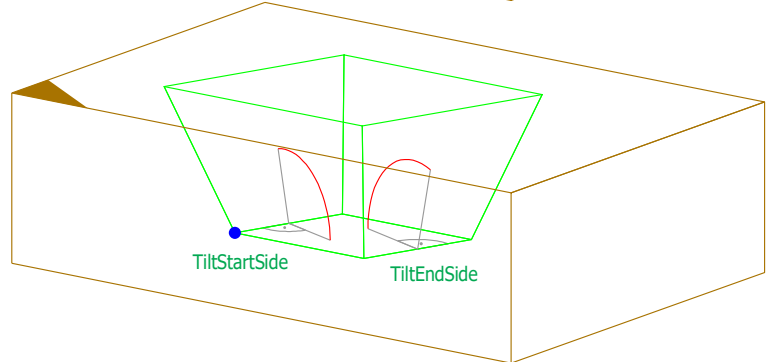
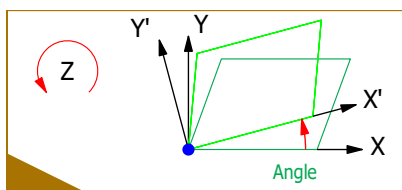
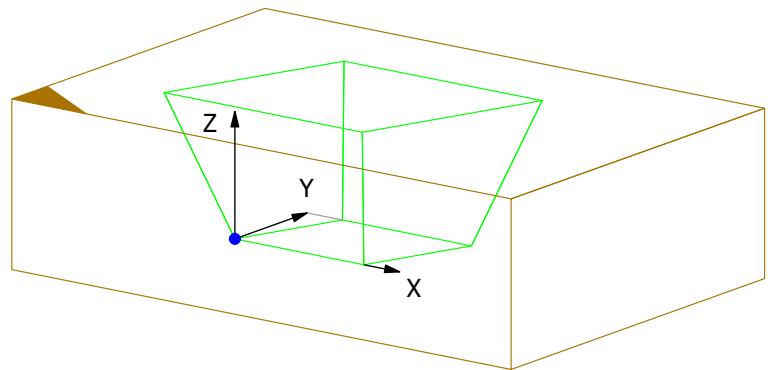
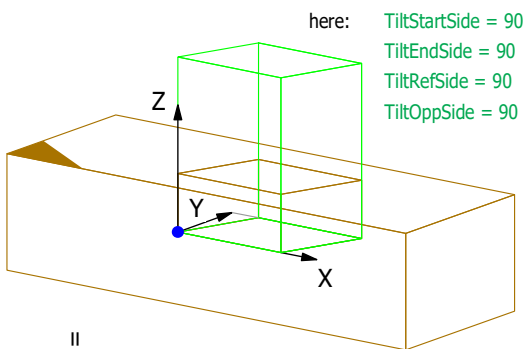
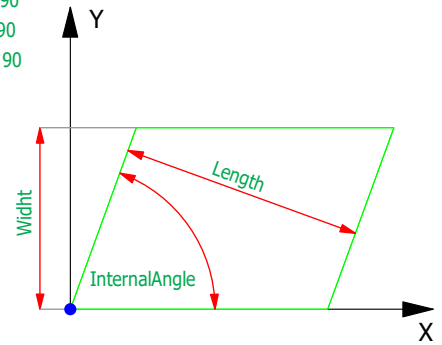
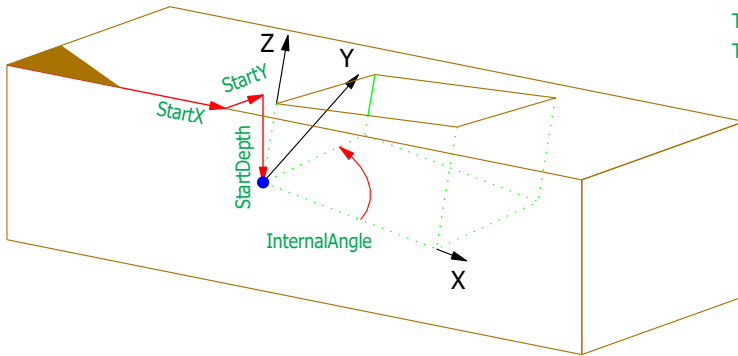

||  
||  
||  
v

||  
||  
||  
v

||  
||  
||  
v

Parameters Pocket

Name	Type	Default	Min	Max
StartX	LengthPosType	0.0	-100000.0	100000.0
StartY	WidthNType	0.0	-50000.0	50000.0
StartDepth	WidthNType	0.0	-50000.0	50000.0
Angle	AngleNType	0.0	-179.9	179.9
Inclination	AngleNType	0.0	-179.9	179.9
Slope	AngleNType	0.0	-179.9	179.9
Length	LengthType	200.0	0.0	100000.0
Width	WidthType	50.0	0.0	50000.0
InternalAngle	AngleType	90.0	0.1	179.9
TiltRefSide	AngleType	90.0	0.1	179.9
TiltEndSide	AngleType	90.0	0.1 </td <td>179.9</td>	179.9
TiltOppSide	AngleType	90.0	0.1	179.9
TiltStartSide	AngleType	90.0	0.1	179.9
MachiningLimits	MachiningLimitType			

MachiningLimits

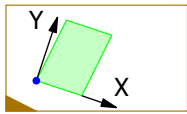

FaceLimitedStart = yes  
 FaceLimitedEnd = yes  
 FaceLimitedFront = yes  
 FaceLimitedBack = yes

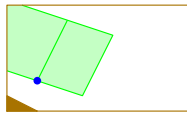

FaceLimitedStart = no  
 FaceLimitedEnd = yes  
 FaceLimitedFront = yes  
 FaceLimitedBack = yes

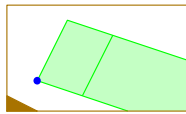

FaceLimitedStart = yes  
 FaceLimitedEnd = no  
 FaceLimitedFront = yes  
 FaceLimitedBack = yes

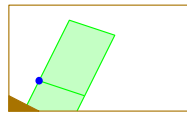

FaceLimitedStart = yes  
 FaceLimitedEnd = yes  
 FaceLimitedFront = no  
 FaceLimitedBack = yes

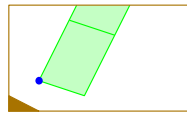

FaceLimitedStart = yes  
 FaceLimitedEnd = yes  
 FaceLimitedFront = yes  
 FaceLimitedBack = no

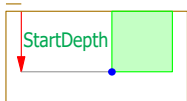

FaceLimitedBottom = yes  
 FaceLimitedTop = no

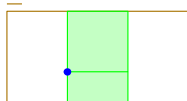

FaceLimitedBottom = no  
 FaceLimitedTop = no

Other combinations of MachineLimits

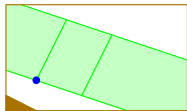

FaceLimitedStart = no  
 FaceLimitedEnd = no  
 FaceLimitedFront = no  
 FaceLimitedBack = yes

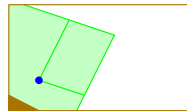

FaceLimitedStart = no  
 FaceLimitedEnd = yes  
 FaceLimitedFront = no  
 FaceLimitedBack = yes

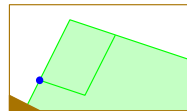

FaceLimitedStart = yes  
 FaceLimitedEnd = no  
 FaceLimitedFront = no  
 FaceLimitedBack = yes

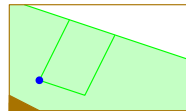

FaceLimitedStart = no  
 FaceLimitedEnd = no  
 FaceLimitedFront = no  
 FaceLimitedBack = yes

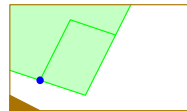

FaceLimitedStart = no  
 FaceLimitedEnd = yes  
 FaceLimitedFront = yes  
 FaceLimitedBack = no

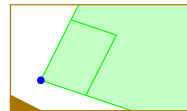

FaceLimitedStart = yes  
 FaceLimitedEnd = no  
 FaceLimitedFront = yes  
 FaceLimitedBack = no

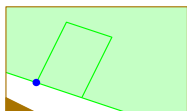

FaceLimitedStart = no  
 FaceLimitedEnd = no  
 FaceLimitedFront = no  
 FaceLimitedBack = no

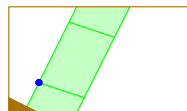

FaceLimitedStart = yes  
 FaceLimitedEnd = yes  
 FaceLimitedFront = no  
 FaceLimitedBack = no

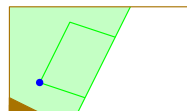

FaceLimitedStart = no  
 FaceLimitedEnd = no  
 FaceLimitedFront = no  
 FaceLimitedBack = no

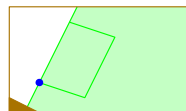

FaceLimitedStart = yes  
 FaceLimitedEnd = no  
 FaceLimitedFront = no  
 FaceLimitedBack = no

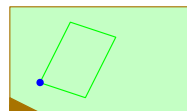

FaceLimitedStart = no  
 FaceLimitedEnd = no  
 FaceLimitedFront = no  
 FaceLimitedBack = no

### Drilling

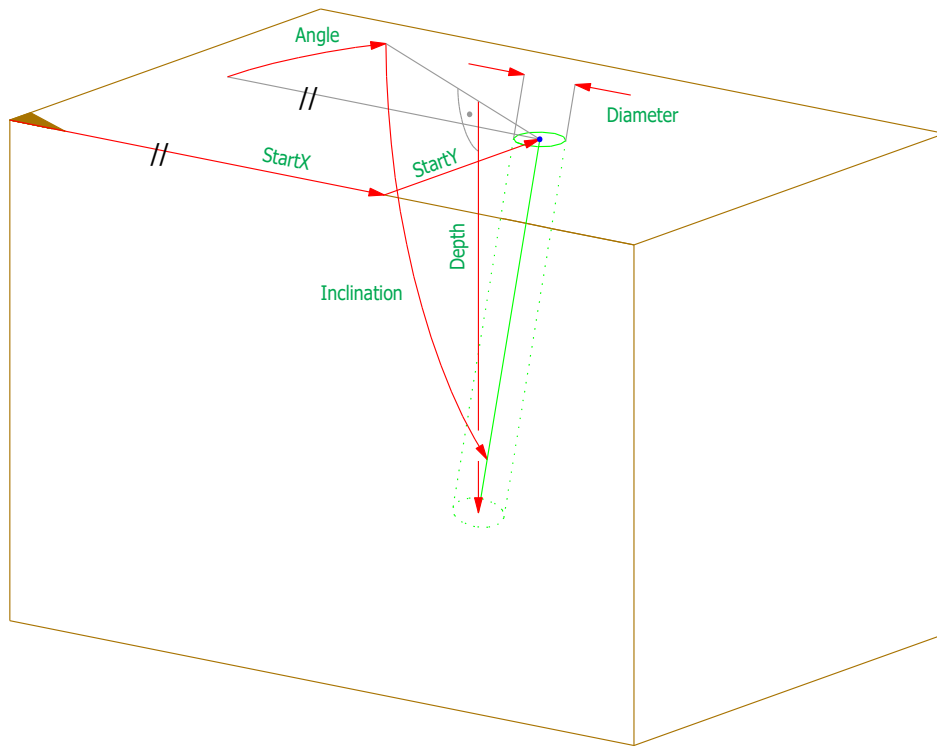

DepthLimited = yes

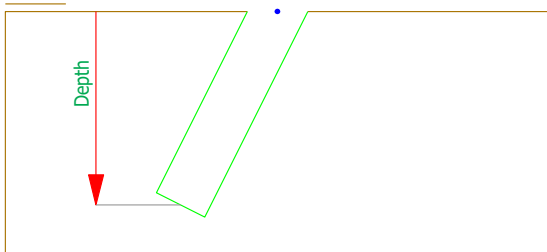

DepthLimited = no

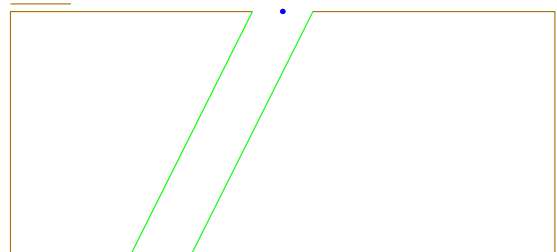



## Parameters Drilling

Name	Type	Default	Min	Max
StartX	LengthPosType	0.0	-100000.0	100000.0
StartY	WidthNType	0.0	-50000.0	50000.0
Angle	Angle3Type	0	0.0	360.0
Inclination	AngleType	90.0	0.1	179.9
DepthLimited	BooleanType	yes	no	yes
Depth	WidthType	50.0	0.0	50000.0
Diameter	DiameterType	20.0	0.0	50000.0

### Tenon

Orientation = start

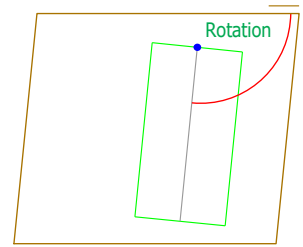
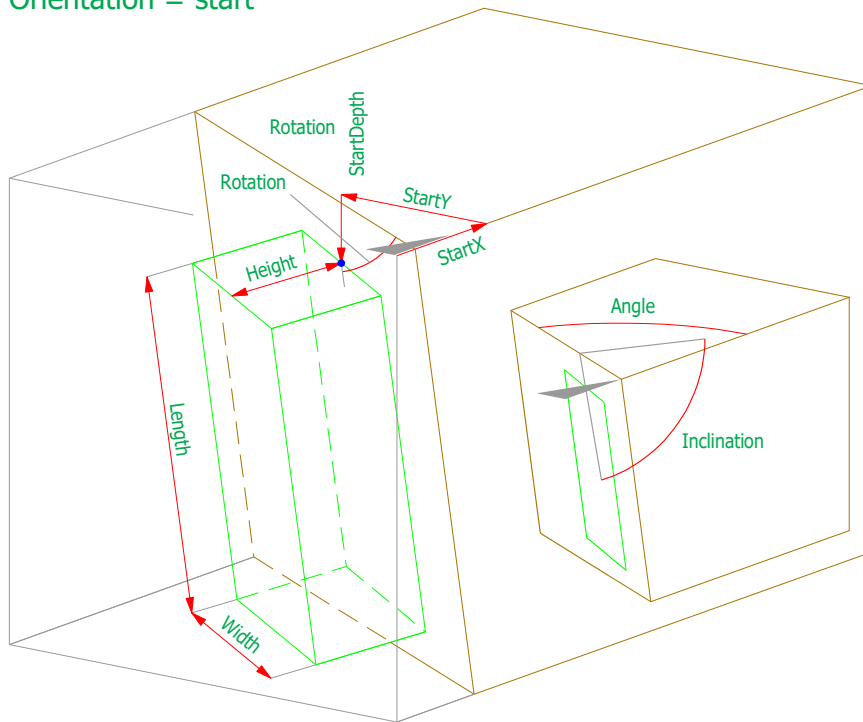

Orientation = end

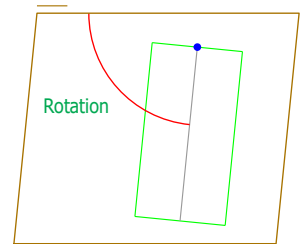
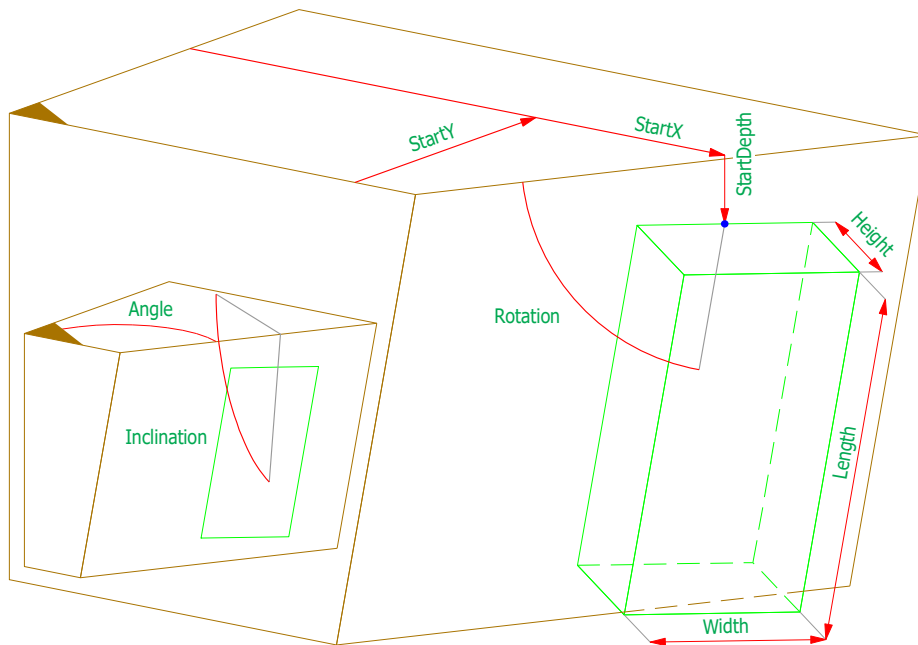

Chamfer = no

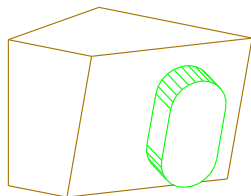

Chamfer = yes

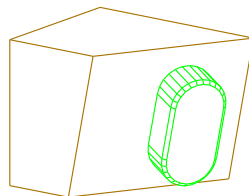

Parameters Tenon

Name	Type	Default	Min	Max
Orientation	OrientationType		start	end
StartX	LengthPosType	0.0	-100000.0	100000.0
StartY	WidthNType	50.0	-50000.0	50000.0
StartDepth	WidthNType	50.0	-50000.0	50000.0
Angle	AngleType	90.0	0.1	179.9
Inclination	AngleType	90.0	0.1	179.9
Rotation	AngleType	90.0	0.1	179.9
LengthLimitedTop	BooleanType	yes	no	yes
LengthLimitedBottom	BooleanType	yes	no	yes
Length	WidthType	80.0	0.0	50000.0
Width	LengthSType	40.0	0.0	1000.0
Height	LengthSType	40.0	0.0	1000.0
Shape	TenonShapeType	automatic		
ShapeRadius	LengthSType	20.0	0.0	1000.0
Chamfer	BooleanType	no	no	yes

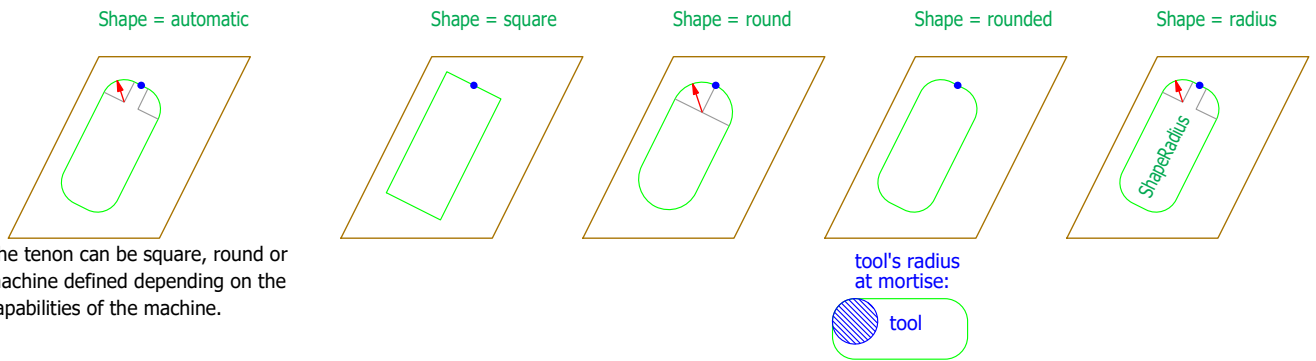

Effective shape View perpendicularly on cut face

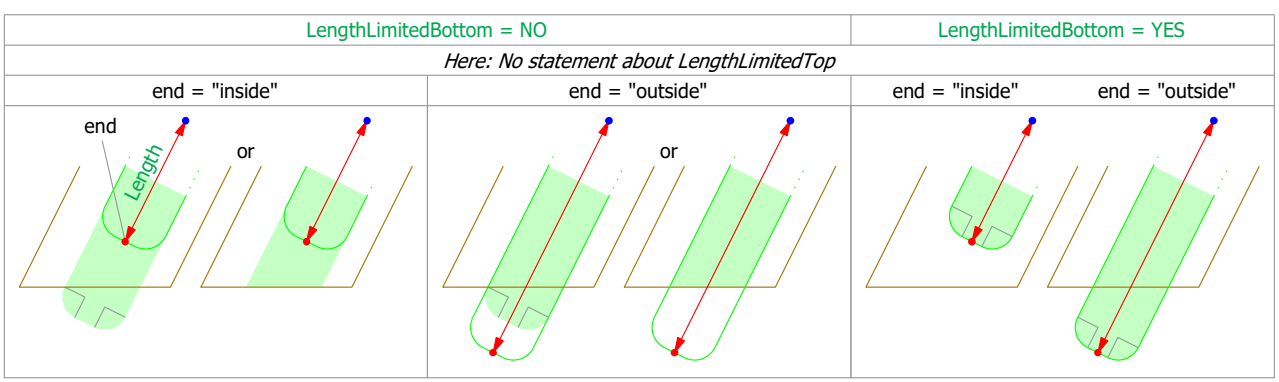
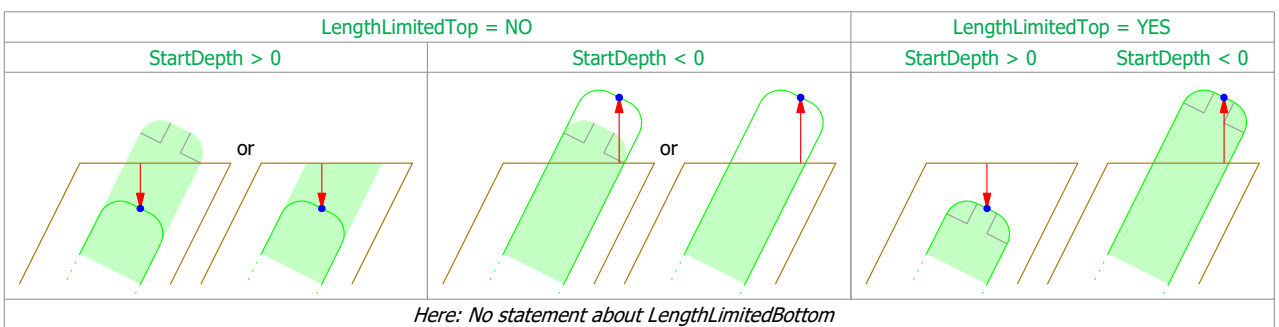

Mortise

Orientation = start

①

Inclination = 90  
Slope = 90

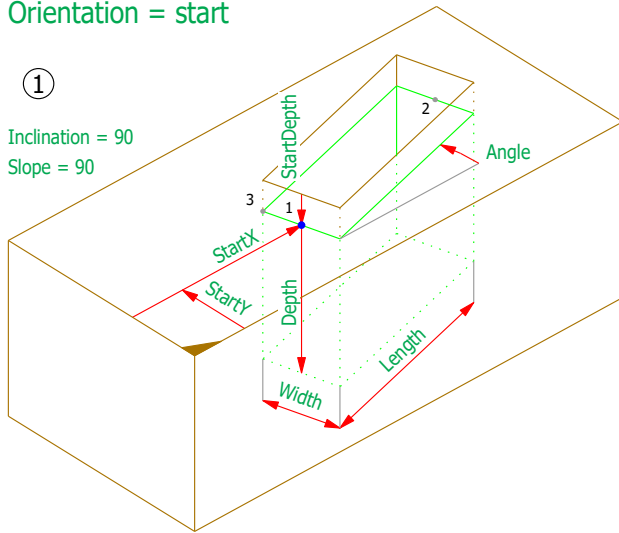

Inclination = 90  
Slope = 90 - rotation(1-3)

||  
||  
v  
②

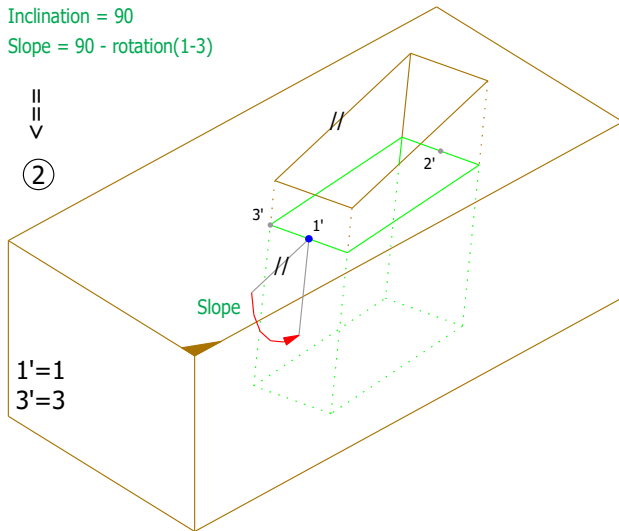

Inclination = 90 - rotation(1'-2')

||  
||  
v  
③

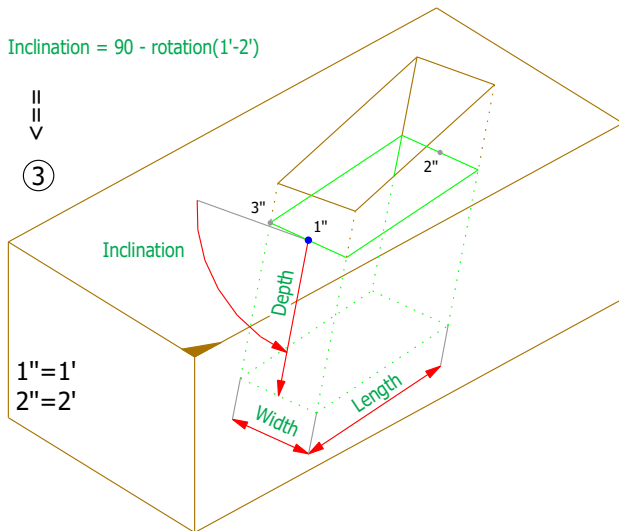

Parameters Mortise

Name	Type	Default	Min	Max
StartX	LengthPosType	0.0	-100000.0	100000.0
StartY	WidthNType	50.0	-50000.0	50000.0
StartDepth	WidthType	0.0	0.0	50000.0
Angle	Angle2NType	0.0	-180.0	180.0
Slope	AngleType	90.0	0.1	179.9
Inclination	AngleType	90.0	0.1	179.9
LengthLimitedTop	BooleanType	yes	no	yes
LengthLimitedBottom	BooleanType	yes	no	yes
Length	WidthType	80.0	0.0	50000.0
Width	LengthSType	40.0	0.0	1000.0
Depth	LengthSType	40.0	0.0	1000.0
Shape	TenonShapeType	automatic		
ShapeRadius	LengthSType	20.0	0.0	1000.0

Shape = automatic

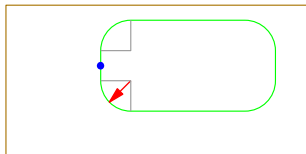

Shape = square

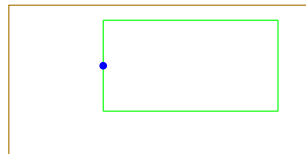

Shape = round

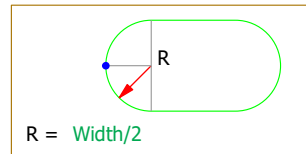

Shape = rounded

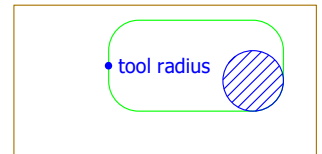

The mortise can be square, round or machine defined, depending on the capabilities of the machine.

Shape = radius

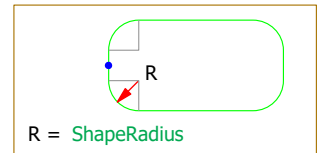

Effective shape

LengthLimitedTop = NO		LengthLimitedTop = YES	
start = "inside"	start = "outside"	start = "inside"	start = "outside"

Here: No statement about LengthLimitedBottom

LengthLimitedBottom = NO		LengthLimitedBottom = YES	
Here: No statement about LengthLimitedTop			
end = "inside"	end = "outside"	end = "inside"	end = "outside"

# House

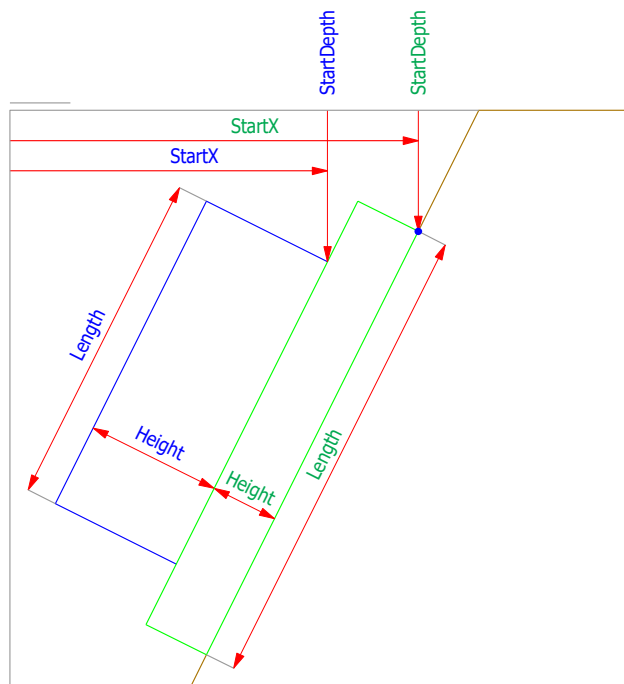
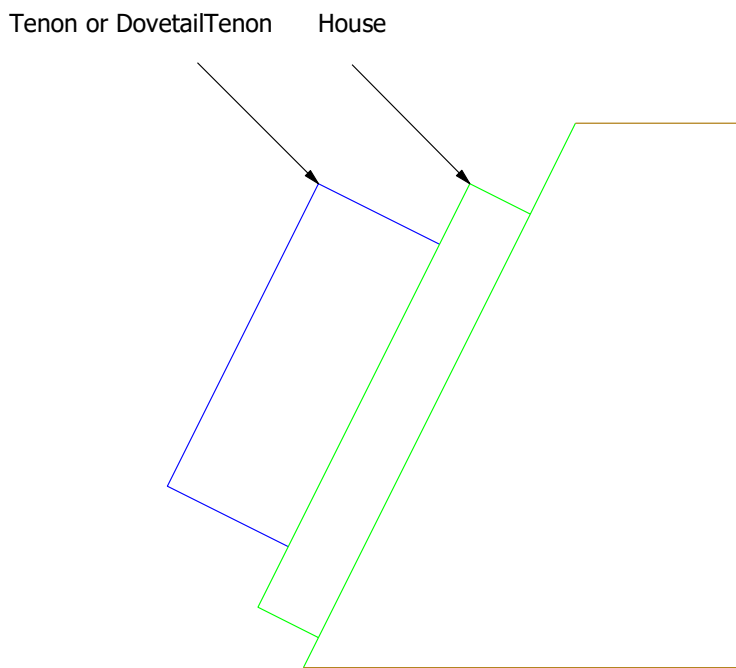

green: Parameters for House.  
blue: Parameters for Tenon or DovetailTenon

## Parameters House

The House has same parameters as the Tenon.

### HouseMortise

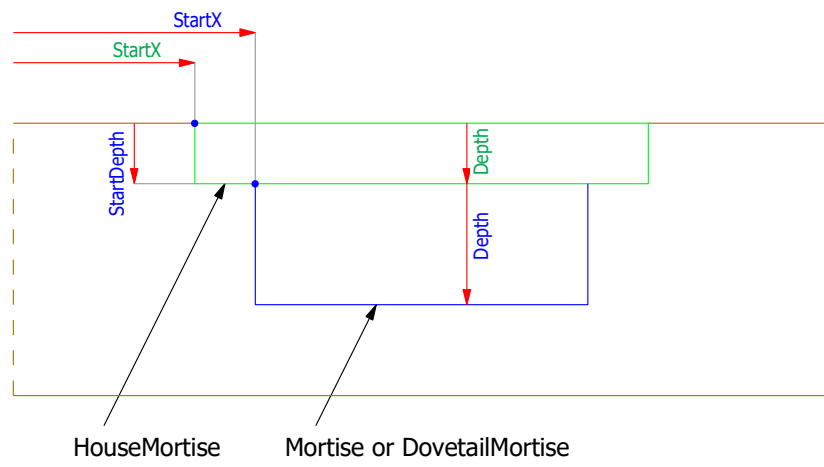



## Parameters HouseMortise

The HouseMortise has same parameters as the Mortise.

### DovetailTenon

Orientation = start

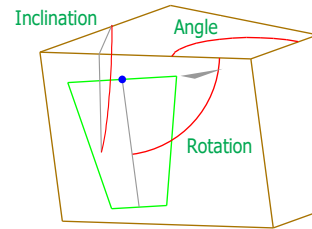
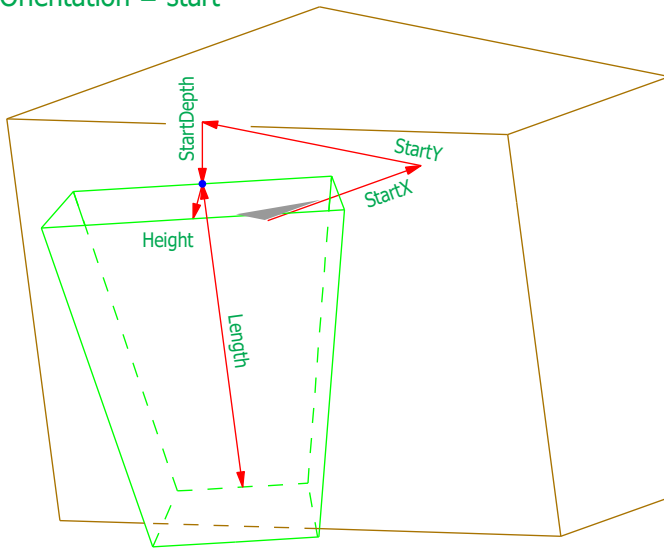

Orientation = end

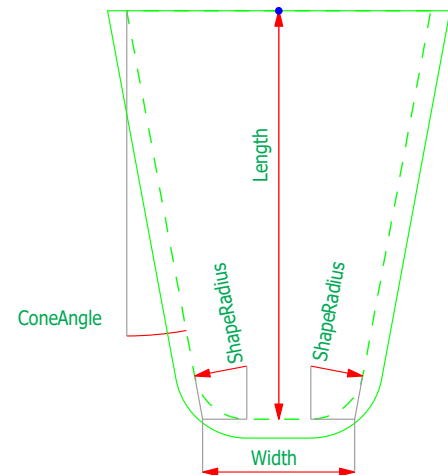
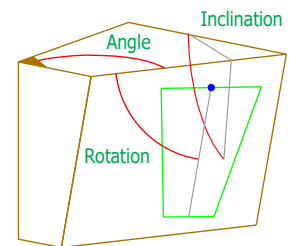
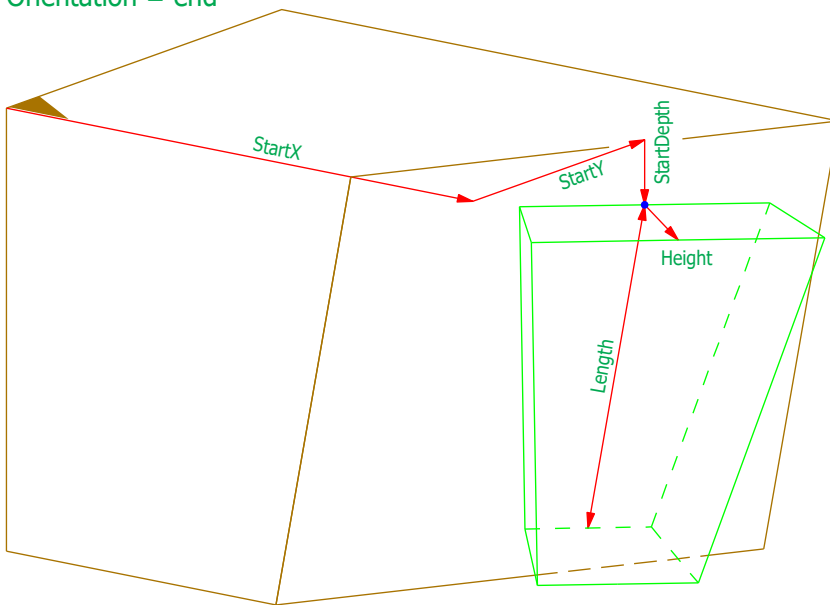

Parameters DovetailTenon

Name	Type	Default	Min	Max
Orientation	OrientationType		start	end
StartX	LengthPosType	0.0	-100000.0	100000.0
StartY	WidthNType	50.0	-50000.0	50000.0
StartDepth	WidthNType	50.0	-50000.0	50000.0
Angle	AngleType	90.0	0.1	179.9
Inclination	AngleType	90.0	0.1	179.9
Rotation	AngleType	90.0	0.1	179.9
LengthLimitedTop	BooleanType	yes	no	yes
LengthLimitedBottom	BooleanType	yes	no	yes
Length	WidthType	80.0	0.0	50000.0
Width	LengthSType	40.0	0.0	1000.0
Height	LengthSType	28.0	0.0	1000.0
ConeAngle	double		0.0	30.0
UseFlankAngle	BooleanType	no	no	yes
FlankAngle	double	15.0	5.0	35.0
Shape	TenonShapeType	automatic		
ShapeRadius	LengthSType	20.0	0.0	1000.0

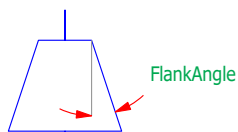
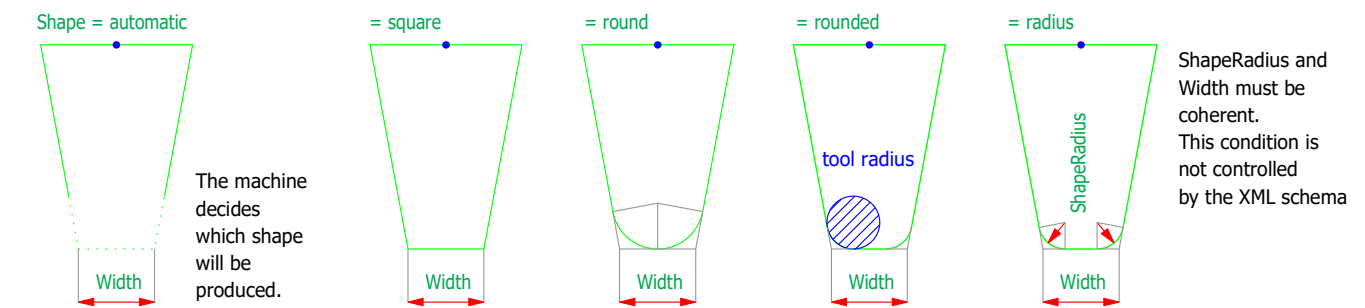
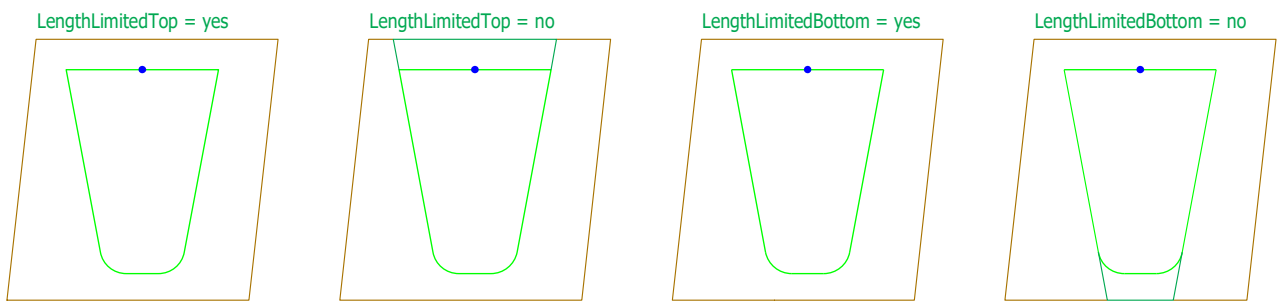

UseFlankAngle = no:  
 Shape of dovetail must be done with FlankAngle of the tool from machine.

UseFlankAngle = yes:  
 Shape of dovetail must be done with the parameter FlankAngle

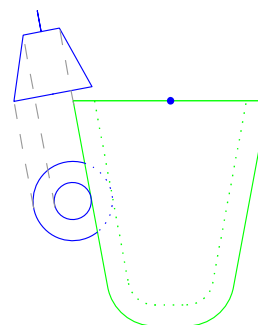

### DovetailMortise

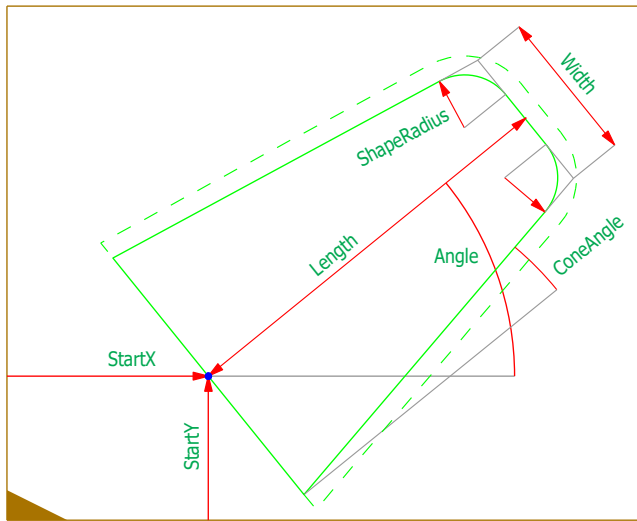

Angle / Slope / Inclination

In case of ReferenceSide 1, 2, 3 and 4

Angle = Rotation  
Slope = Rotation 1-3  
Inclination = Rotation 1'-2'

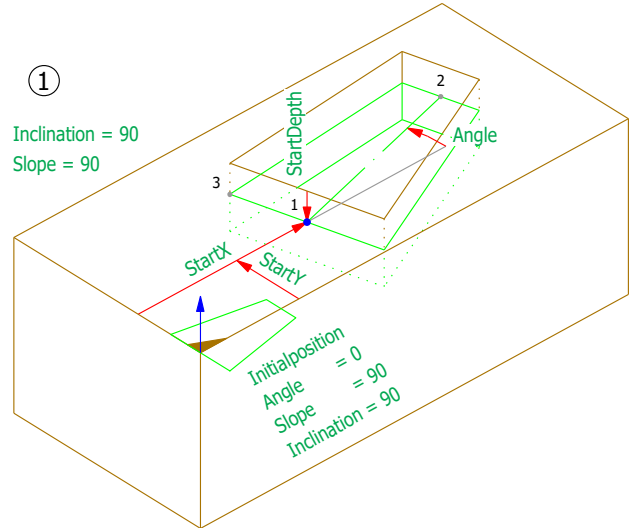

Angle / Slope / Inclination

In case of ReferenceSide 5 and 6

Examples !

Angle = Rotation  
Slope = Rotation 1-3  
Inclination = Rotation 1'-2'

ReferenceSide = 5

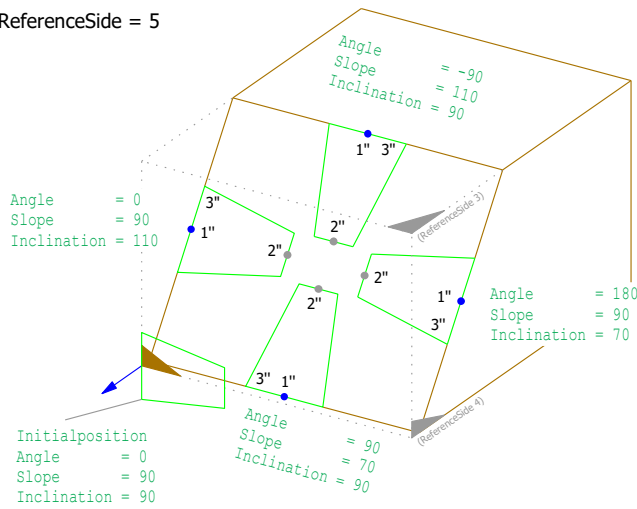

Inclination = 90

Slope = 90 - rotation(1-3)

||  
||  
v

②

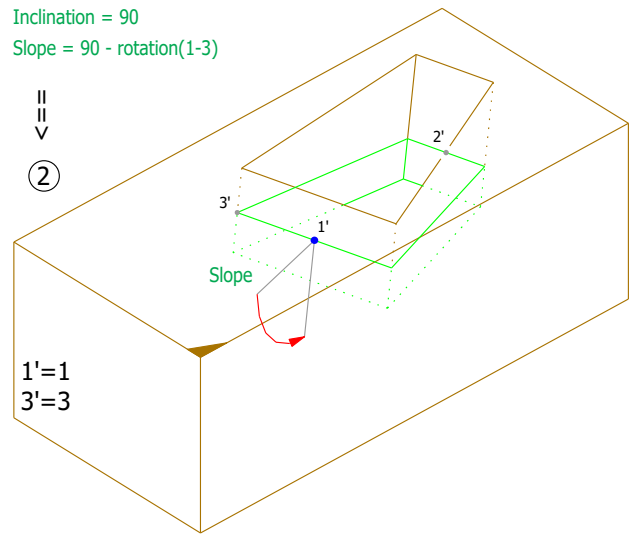

ReferenceSide = 6

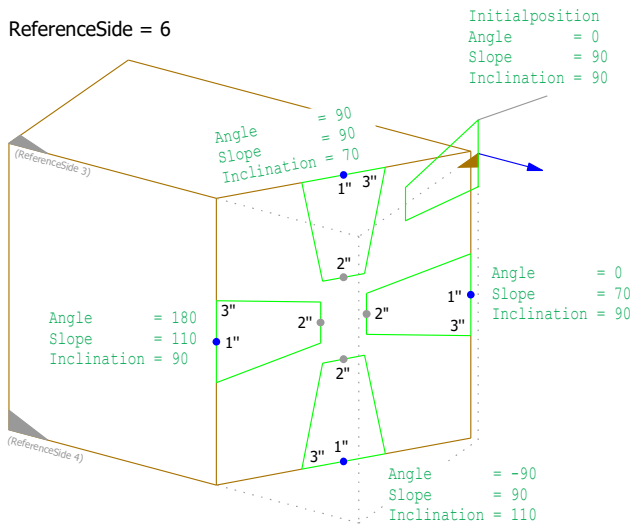

Inclination = 90 - rotation(1'-2')

||  
||  
v

③

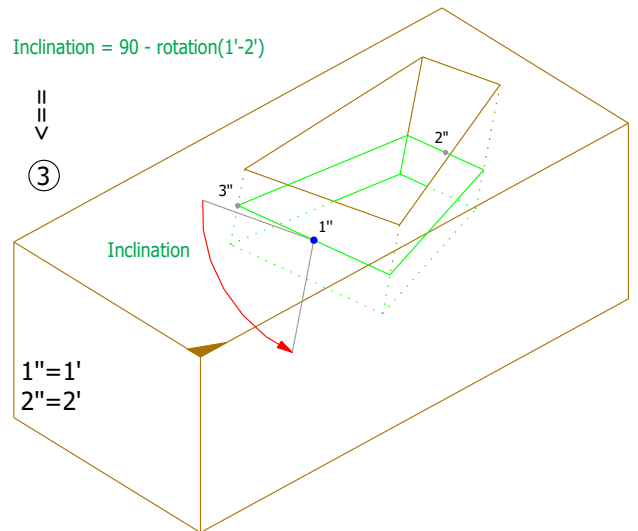

Parameters DovetailMortise

Name	Type	Default	Min	Max
StartX	LengthPosType	0.0	-100000.0	100000.0
StartY	WidthNType	50.0	-50000.0	50000.0
StartDepth	WidthType	0.0	0.0	50000.0
Angle	Angle2NType	0.0	-180.0	180.0
Slope	AngleType	90.0	0.1	179.9
Inclination	AngleType	90.0	0.1	179.9
LimitationTop	LimitationTopType	limited		
LengthLimitedBottom	BooleanType	yes	no	yes
Length	WidthType	80.0	0.0	50000.0
Width	LengthSType	40.0	0.0	1000.0
Depth	LengthSType	28.0	0.0	1000.0
ConeAngle	double		0.0	30.0
UseFlankAngle	BooleanType	no	no	yes
FlankAngle	double	15.0	5.0	35.0
Shape	TenonShapeType	automatic		
ShapeRadius	LengthSType	20.0	0.0	1000.0

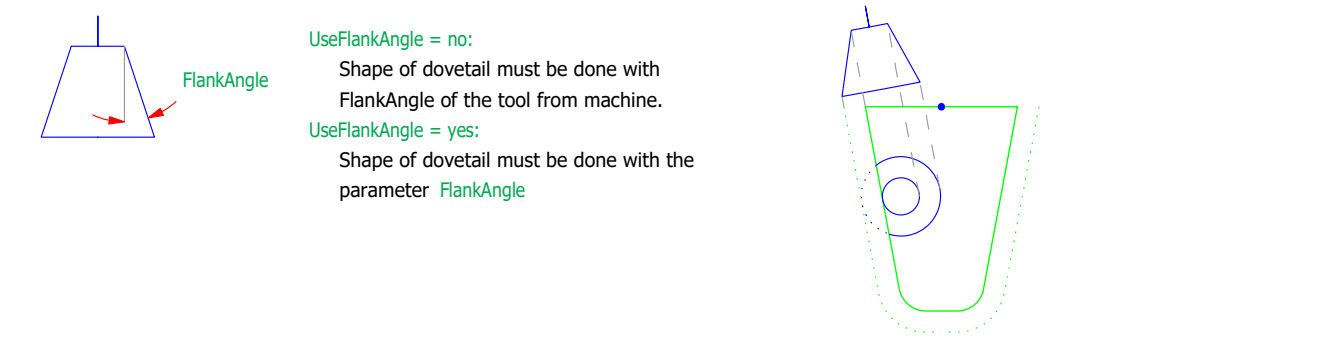
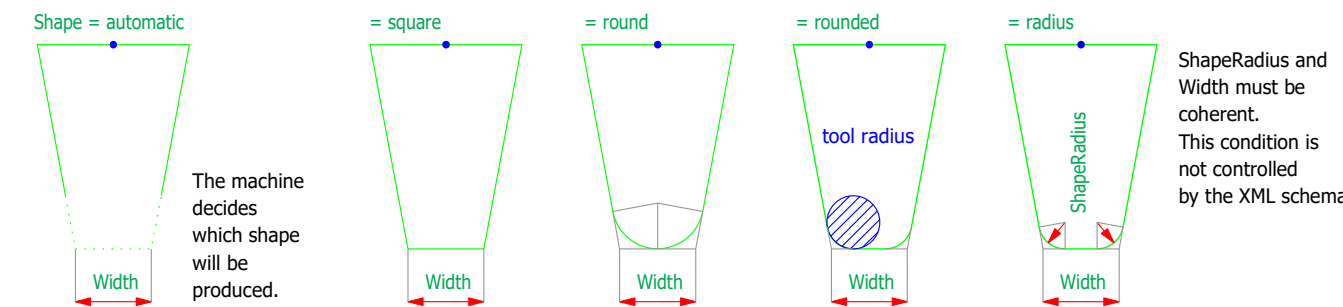
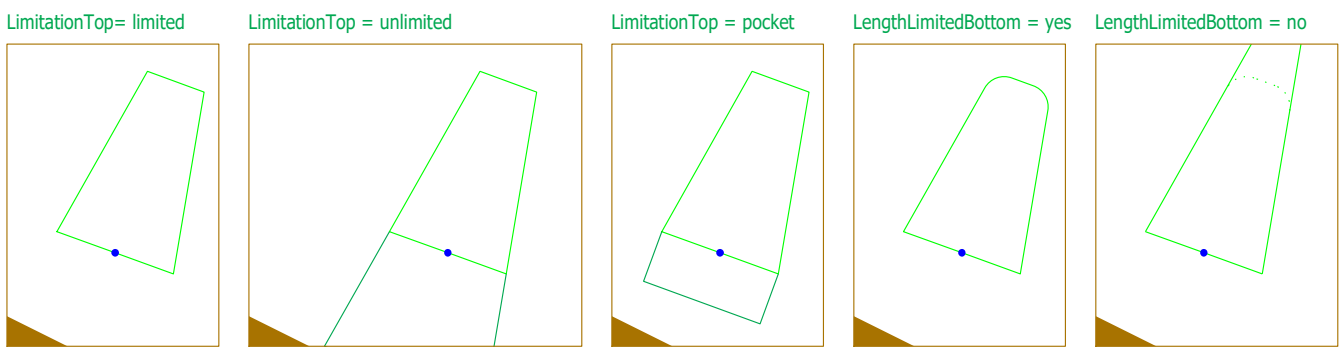

JapaneseMortise

Orientation = start

Orientation = end

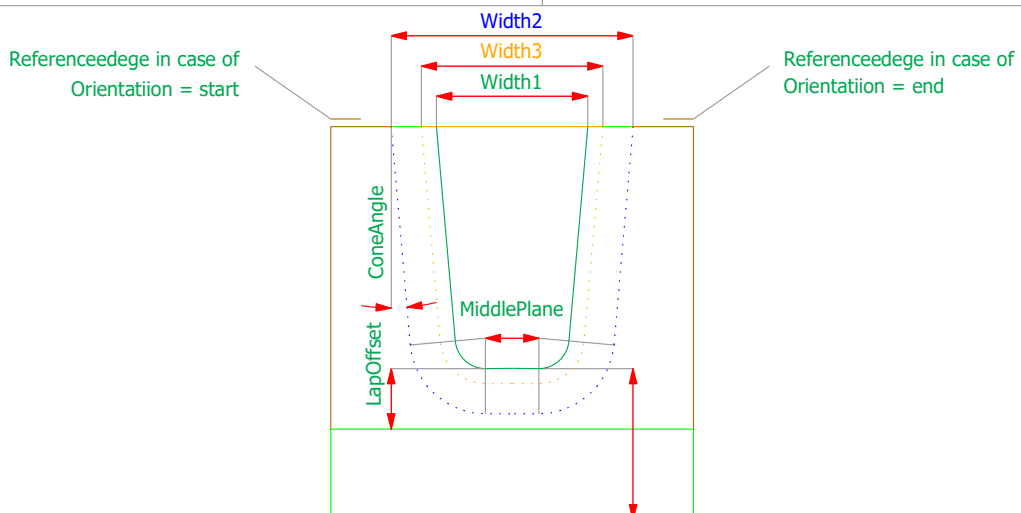
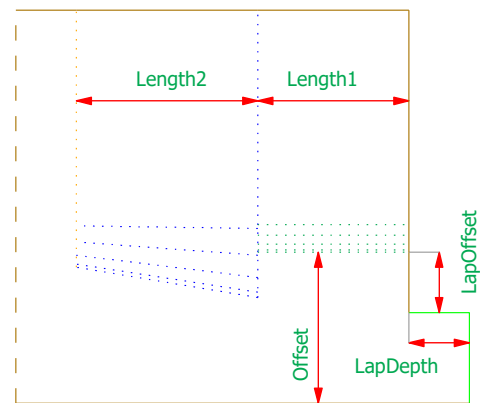
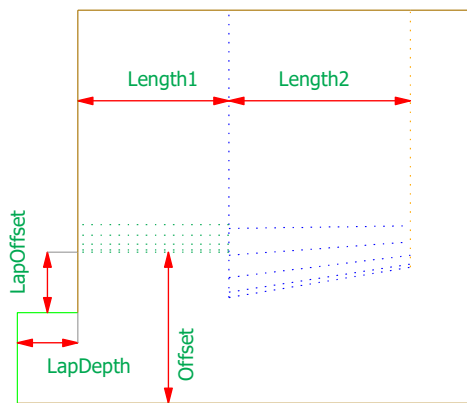
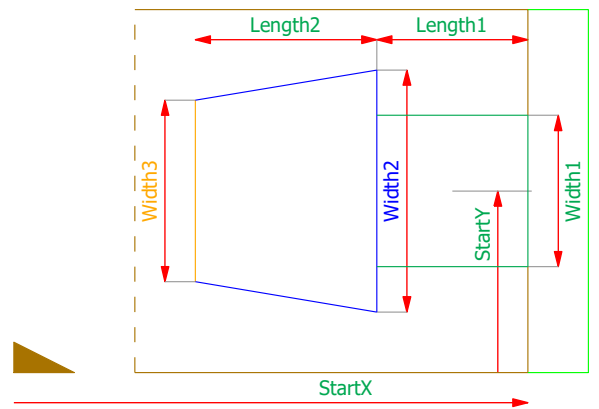
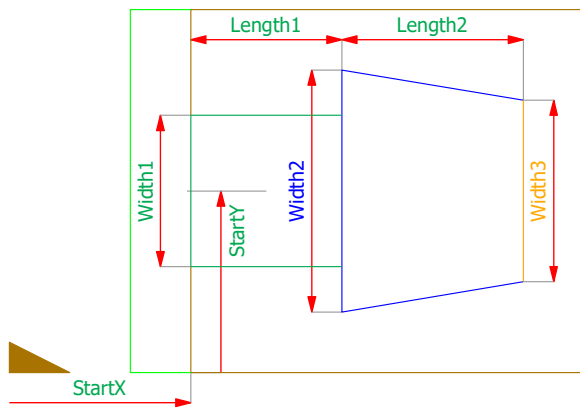
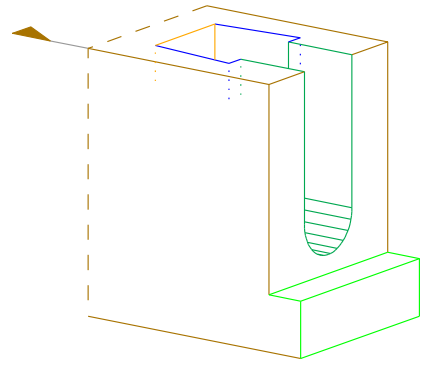
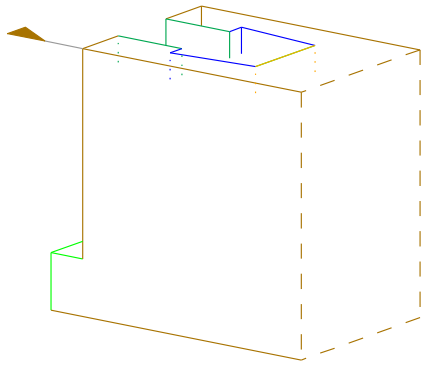

## Parameters JapaneseMortise

Name	Type	Default	Min	Max
StartX	LengthPosType	0.0	-100000.0	100000.0
StartY	WidthNType	50.0	-50000.0	50000.0
Width1	LengthType	40.0	0.0	10000.0
Length1	LengthType	50.0	0.0	10000.0
Width2	LengthType	60.0	0.0	10000.0
Length2	LengthType	50.0	0.0	10000.0
Width3	LengthType	40.0	0.0	10000.0
ConeAngle	Double	30.0	0.0	30.0
MiddlePlane	LengthType	0.0	0.0	10000.0
Offset	LengthType	30.0	0.0	10000.0
UseLap	BooleanType	yes	no	yes
LapOffset	LengthType	10.0	0.0	10000.0
LapDepth	LengthType	20.0	0.0	10000.0

JapaneseTenon

Orientation = start

Orientation = end

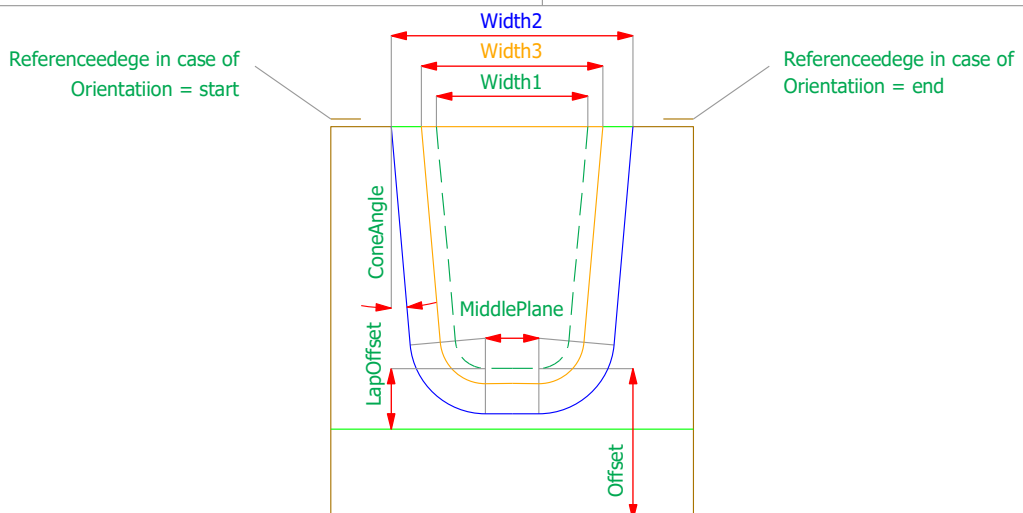
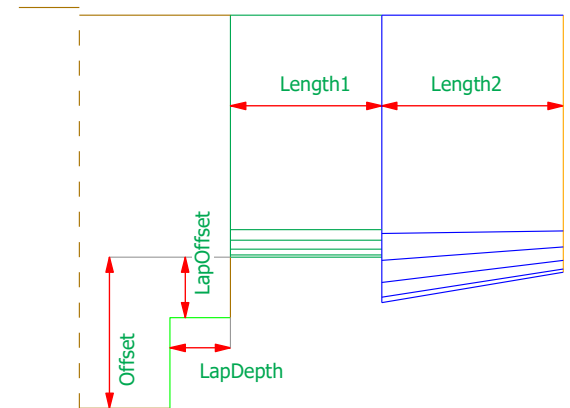
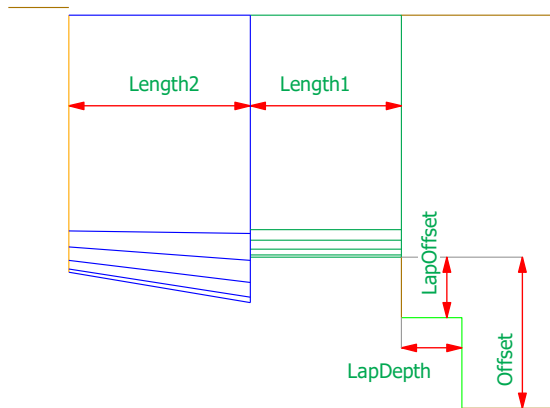
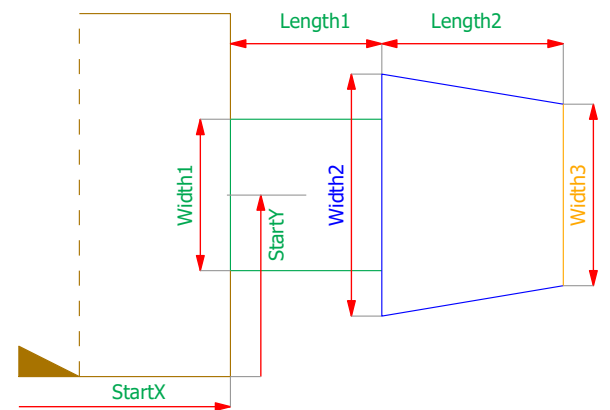
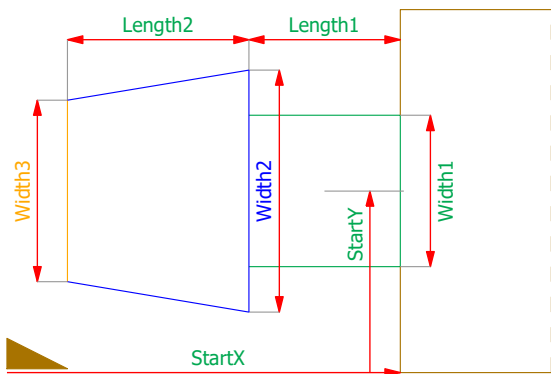
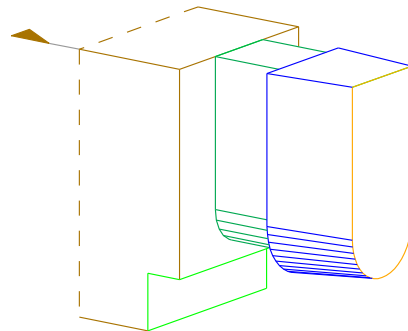
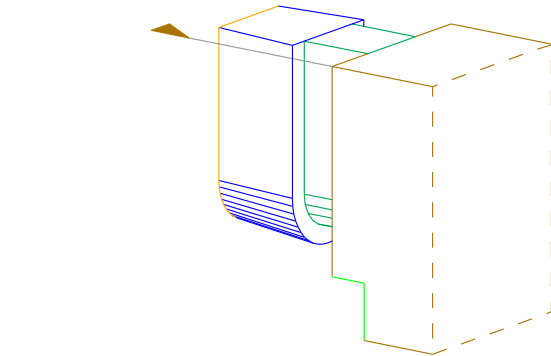



## Parameters JapaneseTenon

Name	Type	Default	Min	Max
StartX	LengthPosType	0.0	-100000.0	100000.0
StartY	WidthNType	50.0	-50000.0	50000.0
Width1	LengthType	40.0	0.0	10000.0
Length1	LengthType	50.0	0.0	10000.0
Width2	LengthType	60.0	0.0	10000.0
Length2	LengthType	50.0	0.0	10000.0
Width3	LengthType	40.0	0.0	10000.0
ConeAngle	Double	30.0	0.0	30.0
MiddlePlane	LengthType	0.0	0.0	10000.0
Offset	LengthType	30.0	0.0	10000.0
UseLap	BooleanType	yes	no	yes
LapOffset	LengthType	10.0	0.0	10000.0
LapDepth	LengthType	20.0	0.0	10000.0

### Marking

MarkingStyle = single

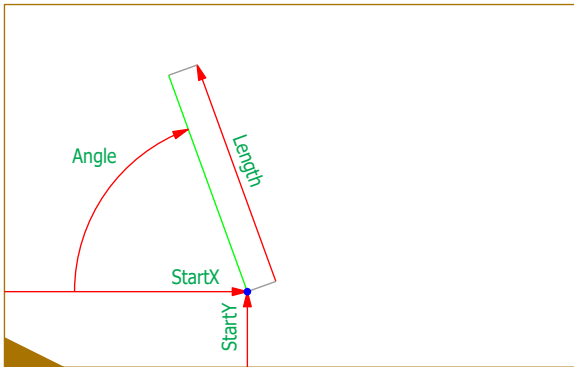

MarkingStyle = double

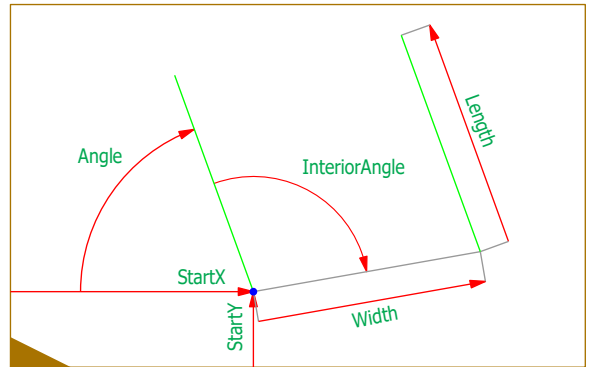

MarkingStyle = square

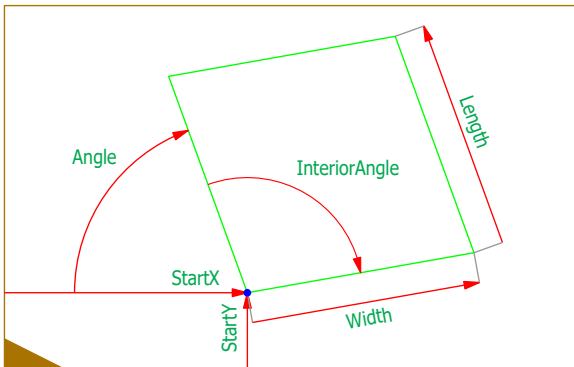

## Parameters Marking

Name	Type	Default	Min	Max
StartX	LengthPosType	0.0	-100000.0	100000.0
StartY	WidthNType	0.0	-50000.0	50000.0
Angle	Angle2NType	0	-180.0	180.0
LengthLimited	BooleanType	no	no	yes
Length	WidthType	20.0	0.0	50000.0
Width	WidthType	100.0	0.0	50000.0
InteriorAngle	AngleType	90.0	0.1	179.9
Style	MarkingStyleType	single	single/double/square	

Text

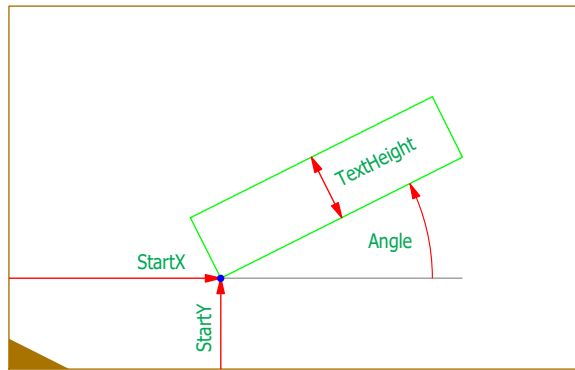

Text = "ABCD"

		AlignmentHorizontal		
		left	center	right
AlignmentVertical	bottom			
	center			
	top			

Text = "ABCD\nEF\nGHI"

AlignmentMultiline				
		left	center	right

StackedMarking	
no	yes

## Parameters Text

Name	Type	Default	Min	Max
StartX	LengthPosType	0	-100000	100000
StartY	WidthNType	0	-50000	50000
Angle	Angle2NType	0	-180	180
AlignmentVertical	AlignmentVerticalType	bottom		
AlignmentHorizontal	AlignmentHorizontalType	left		
AlignmentMultiline	AlignmentHorizontalType	left		
StackedMarking	BooleanType	no	no	yes
TextHeightAuto	BooleanType	yes	no	yes
TextHeight	WidthType	20	0	50000
Text	xs:string			

### SimpleScarf

Orientation = start

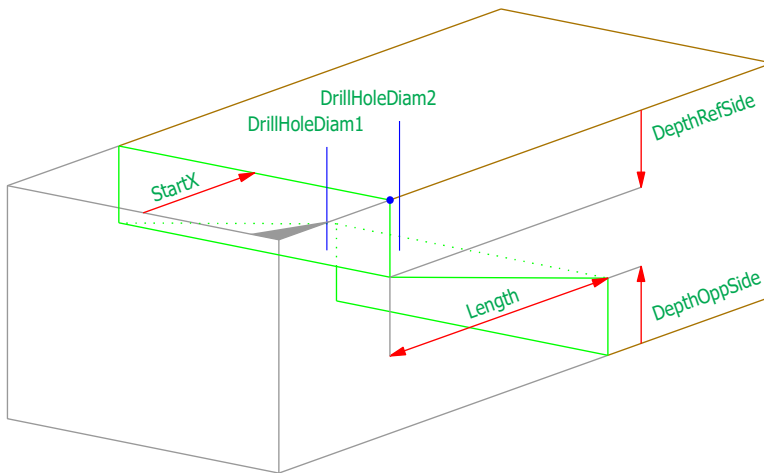

Orientation = end

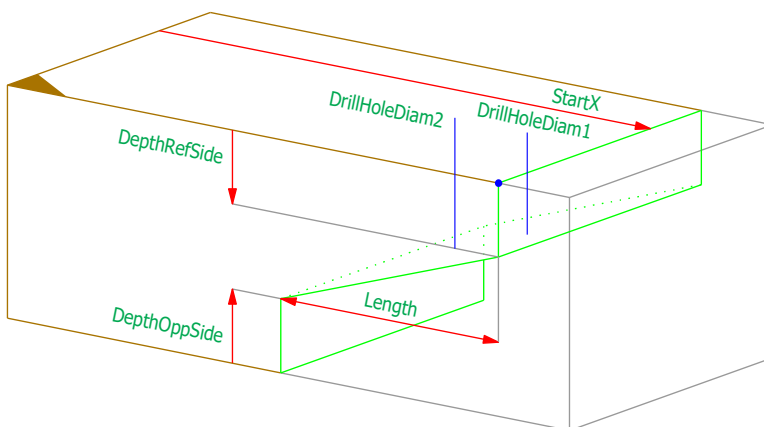

This processing trims the part, even it is on a ReferencePlane

Examples:



## Parameters SimpleScarf

Name	Type	Default	Min	Max
Orientation	OrientationType		start	end
StartX	LengthPosType	0.0	-100000.0	100000.0
Length	WidthType	200.0	0.0	50000.0
DepthRefSide	WidthType	20.0	0.0	50000.0
DepthOppSide	WidthType	20.0	0.0	50000.0
NumDrillHole	byte	0	0	2
DrillHoleDiam1	LengthSType	20.0	0.0	1000.0
DrillHoleDiam2	LengthSType	20.0	0.0	1000.0

### ScarfJoint

Orientation = start

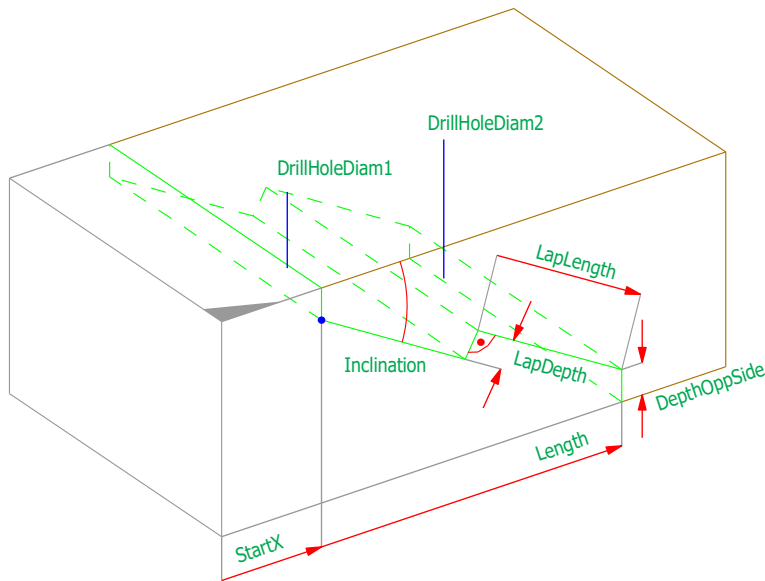

ScarfShape = classic

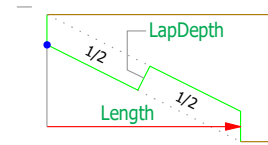

ScarfShape = refside

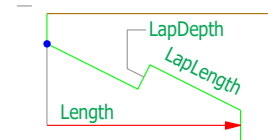

ScarfShape = baseside

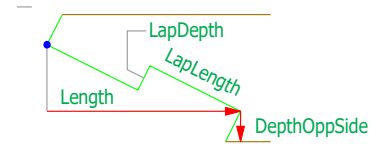

Orientation = end

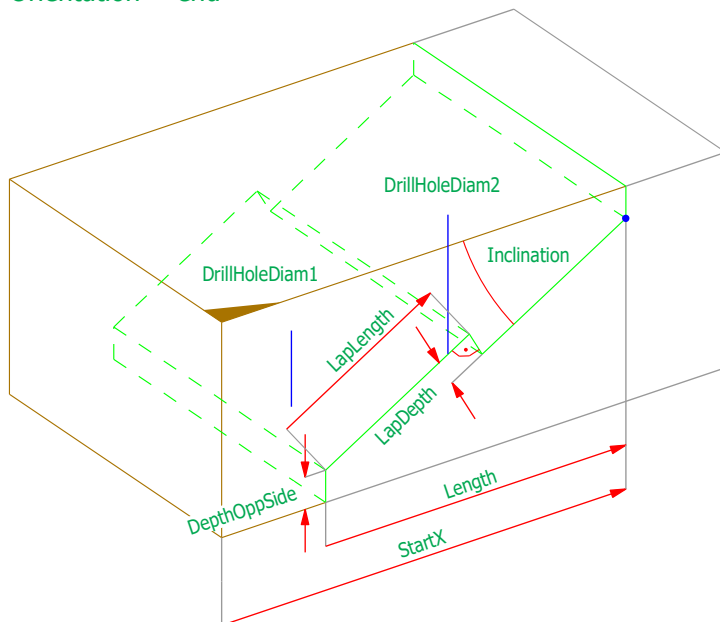

ScarfShape = classic

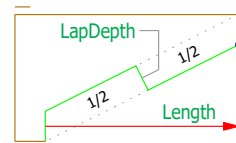

ScarfShape = refside

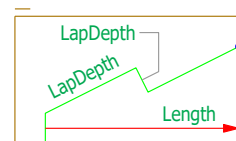

ScarfShape = baseside

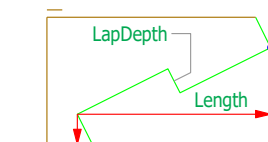

This processing trims the part, even it is on a ReferencePlane  
Examples:





## Parameters ScarfJoint

Name	Type	Default	Min	Max
Orientation	OrientationType		start	end
StartX	LengthPosType	0.0	-100000.0	100000.0
Inclination	Inclination3Type		0.0	90.0
LapLength	WidthType	100.0	0.0	50000.0
LapDepth	WidthType	20.0	0.0	50000.0
Length	WidthType	200.0	0.0	50000.0
DepthOppSide	WidthType	20.0	0.0	50000.0
ScarfShape	ScarfShapeType	refside		
NumDrillHole	byte	0	0	2
DrillHoleDiam1	LengthSType	20.0	0.0	1000.0
DrillHoleDiam2	LengthSType	20.0	0.0	1000.0

### StepJoint

Tenon = no

Orientation = start

Orientation = end

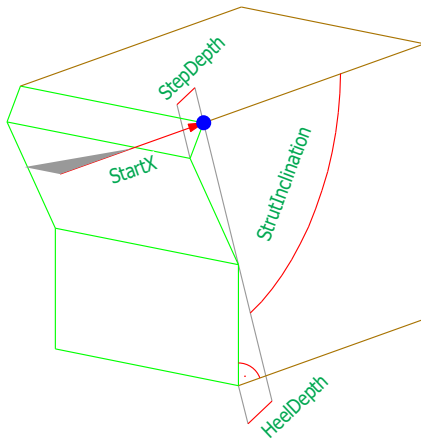

StepShape = double

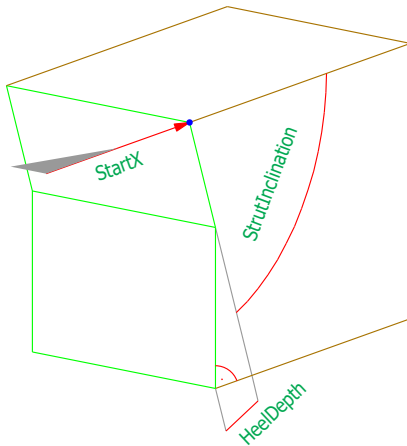
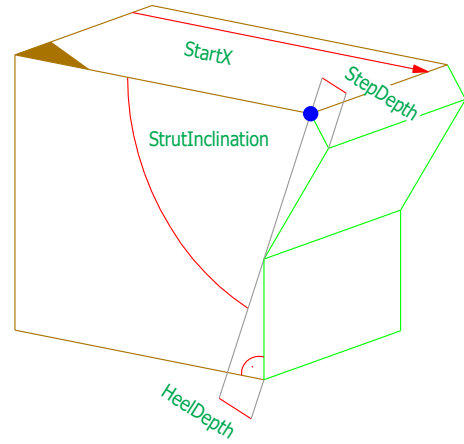

StepShape = step

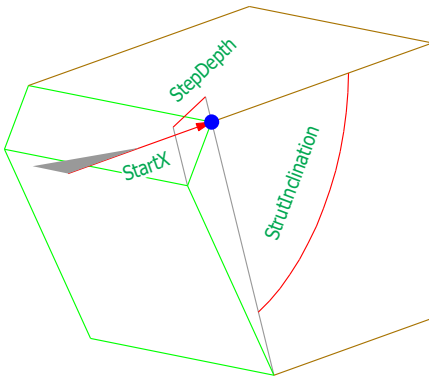
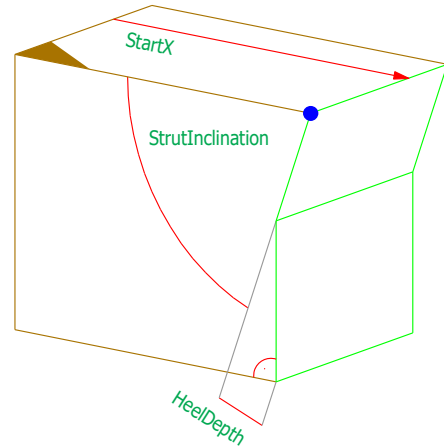

StepShape = heel

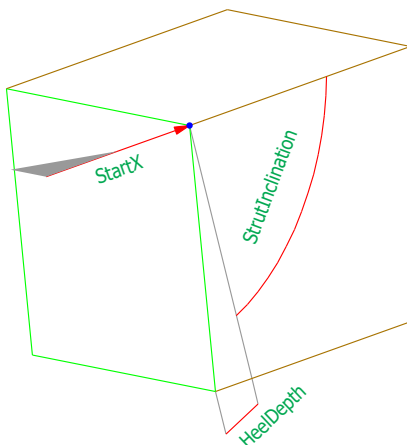
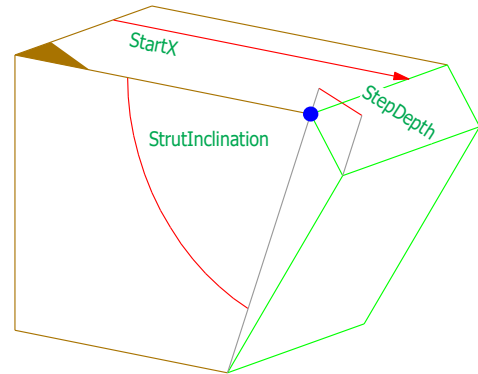

StepShape = taperedheel

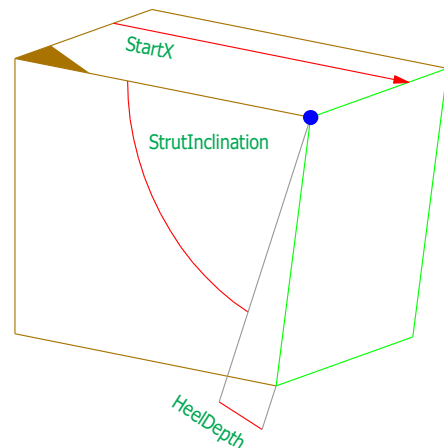

Tenon = yes

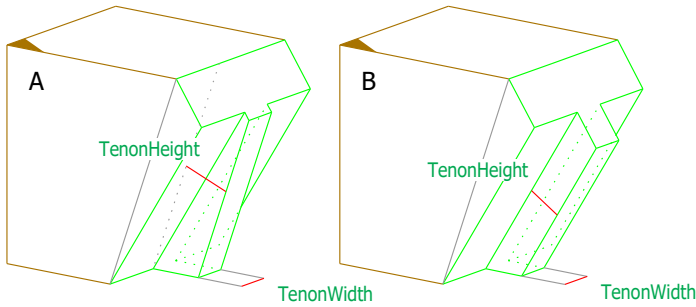

Which style (A or B) is used depends on the machine

### Parameters StepJoint

Name	Type	Default	Min	Max
Orientation	OrientationType		start	end
StartX	LengthPosType	0.0	-100000.0	100000.0
StrutInclination	AngleType		0.1	179.9
StepDepth	WidthType	20.0	0.0	50000.0
HeelDepth	WidthType	20.0	0.0	50000.0
StepShape	StepShapeType	double		
Tenon	BooleanType	no	no	yes
TenonWidth	LengthSType	40.0	0.0	1000.0
TenonHeight	LengthSType	40.0	0.0	1000.0

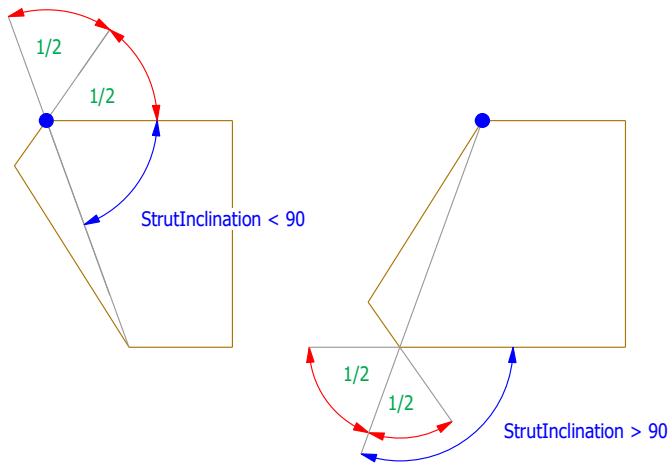

This processing trims the part, even it is on a ReferencePlane

Examples:



### StepJointNotch

Orientation = start

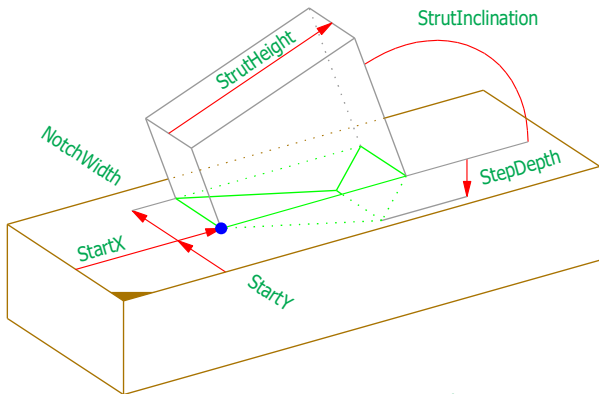

StepShape = step

Orientation = end

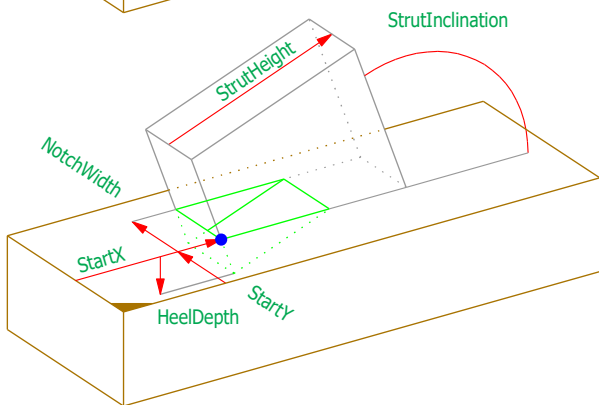
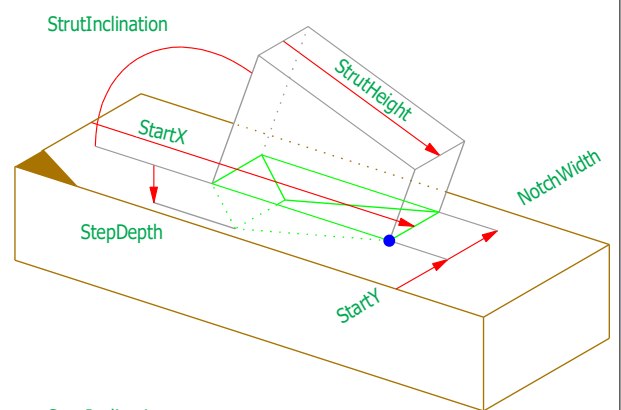

StepShape = heel

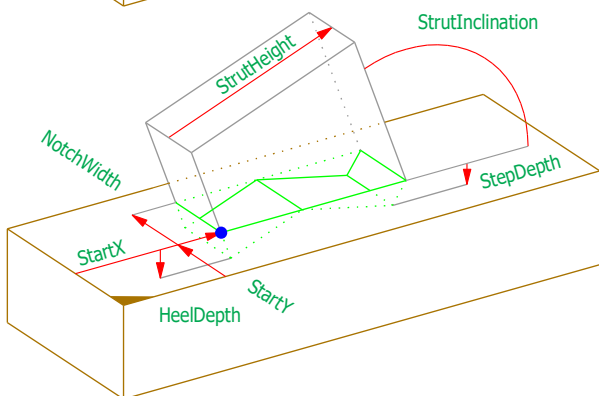
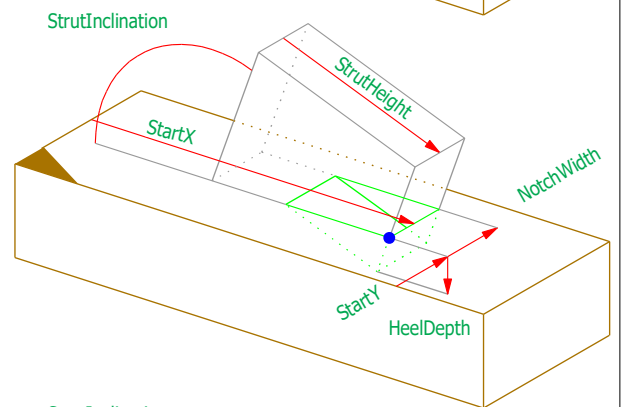

StepShape = double

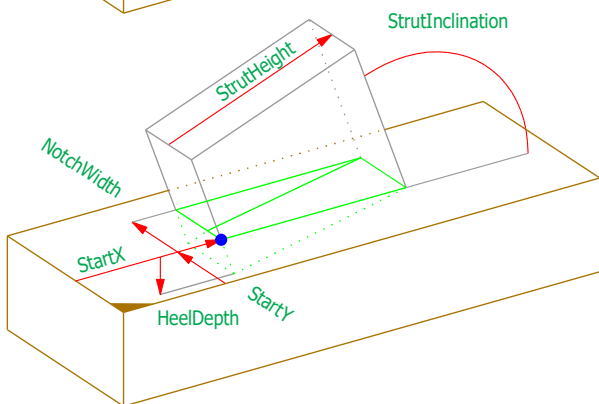
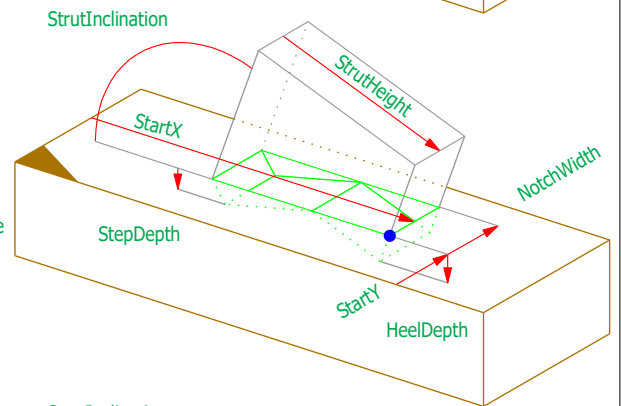

StepShape = taperedheel

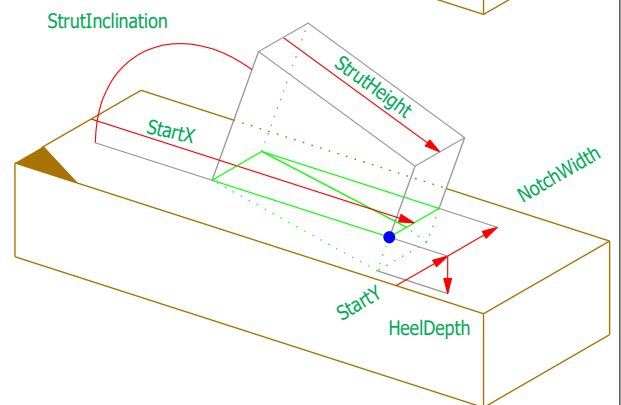

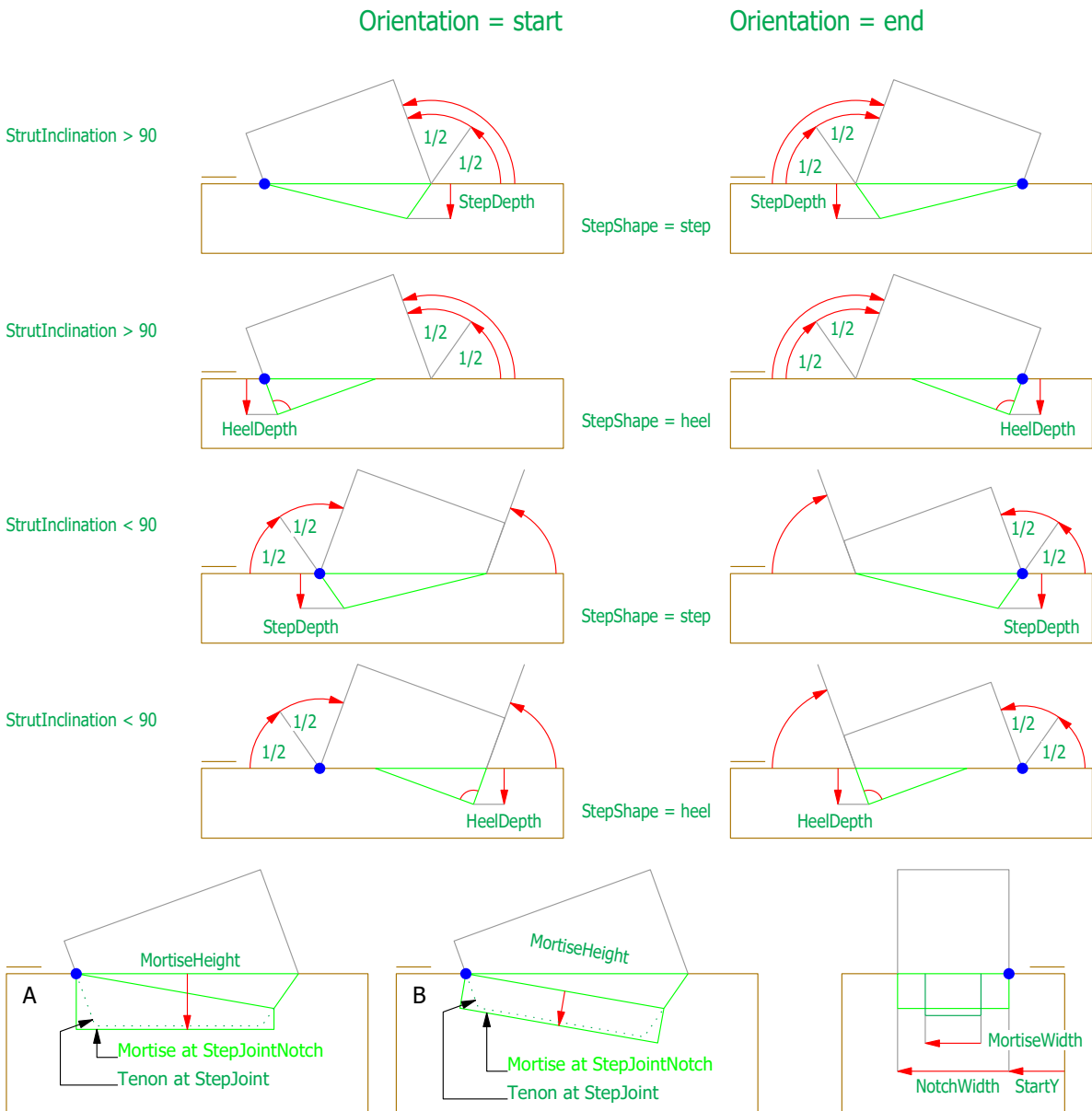

Parameters StepJointNotch

Name	Type	Default	Min	Max
Orientation	OrientationType		start	end
StartX	LengthPosType	0.0	-100000.0	100000.0
StartY	WidthNType	0.0	-50000.0	50000.0
StrutInclination	AngleType		0.1	179.9
NotchLimited	BooleanType	no	no	yes
NotchWidth	WidthType	20.0	0.0	50000.0
StepDepth	WidthType	20.0	0.0	50000.0
HeelDepth	WidthType	20.0	0.0	50000.0
StrutHeight	WidthType	20.0	0.0	50000.0
StepShape	StepShapeType	double		
Mortise	BooleanType	no	no	yes
MortiseWidth	LengthSType	40.0	0.0	1000.0
MortiseHeight	LengthSType	40.0	0.0	1000.0

Planing

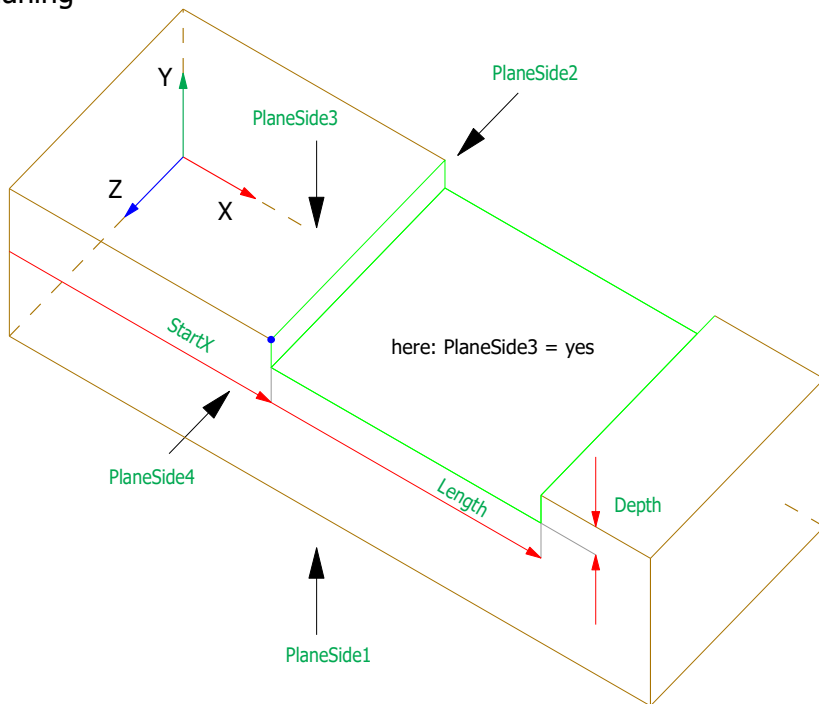

StartLimited	EndLimited	
yes	yes	
no	yes	
yes	no	
no	no	

Examples

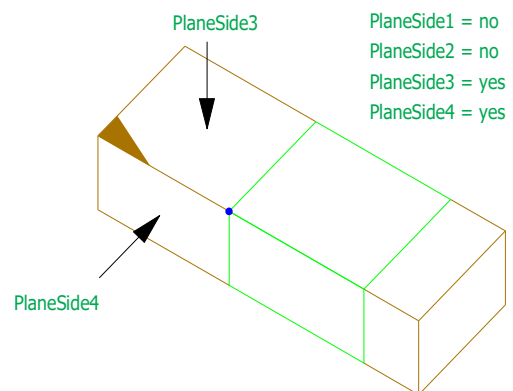
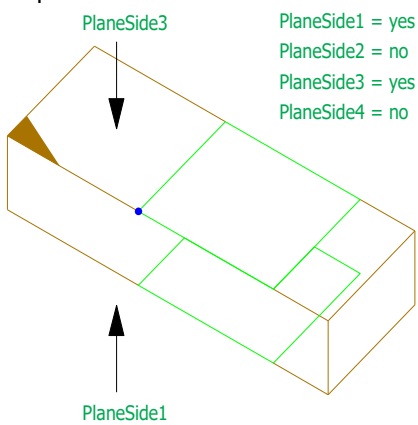

## Parameters Planing

Name	Type	Default	Min	Max
StartX	LengthPosType	0.0	-100000.0	100000.0
Length	LengthType	0.0	0.0	100000.0
Depth	double	1.0	0.0	50.0
StartLimited	BooleanType	no	no	yes
EndLimited	BooleanType	no	no	yes
PlaneSide1	BooleanType	yes	no	yes
PlaneSide2	BooleanType	yes	no	yes
PlaneSide3	BooleanType	yes	no	yes
PlaneSide4	BooleanType	yes	no	yes

### ProfileFront

Orientation = start

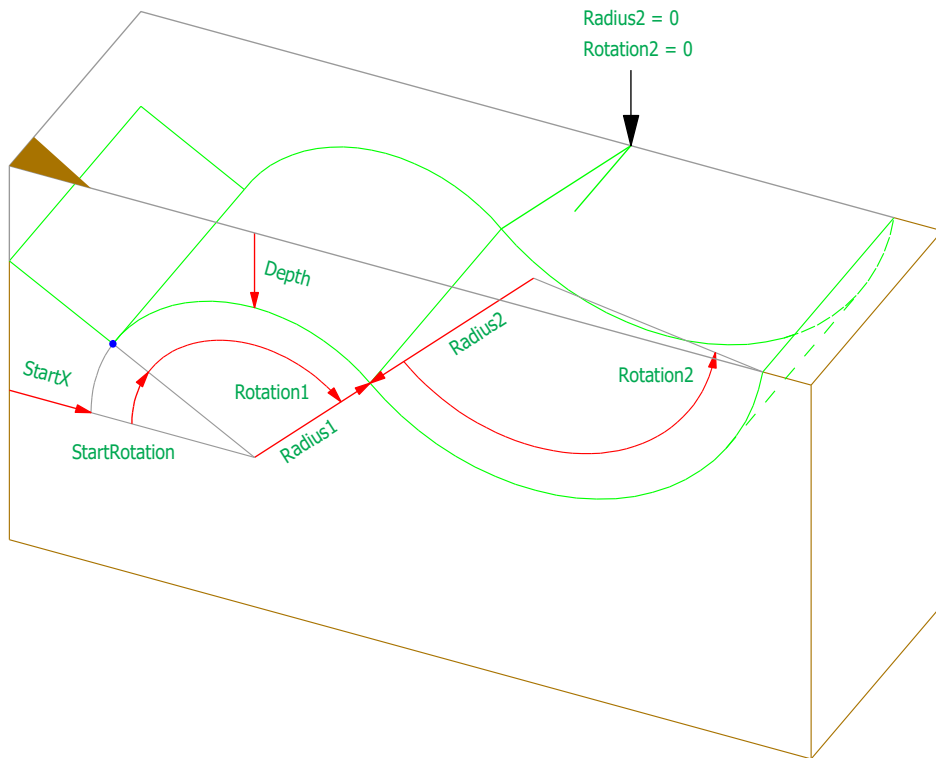

Orientation = end

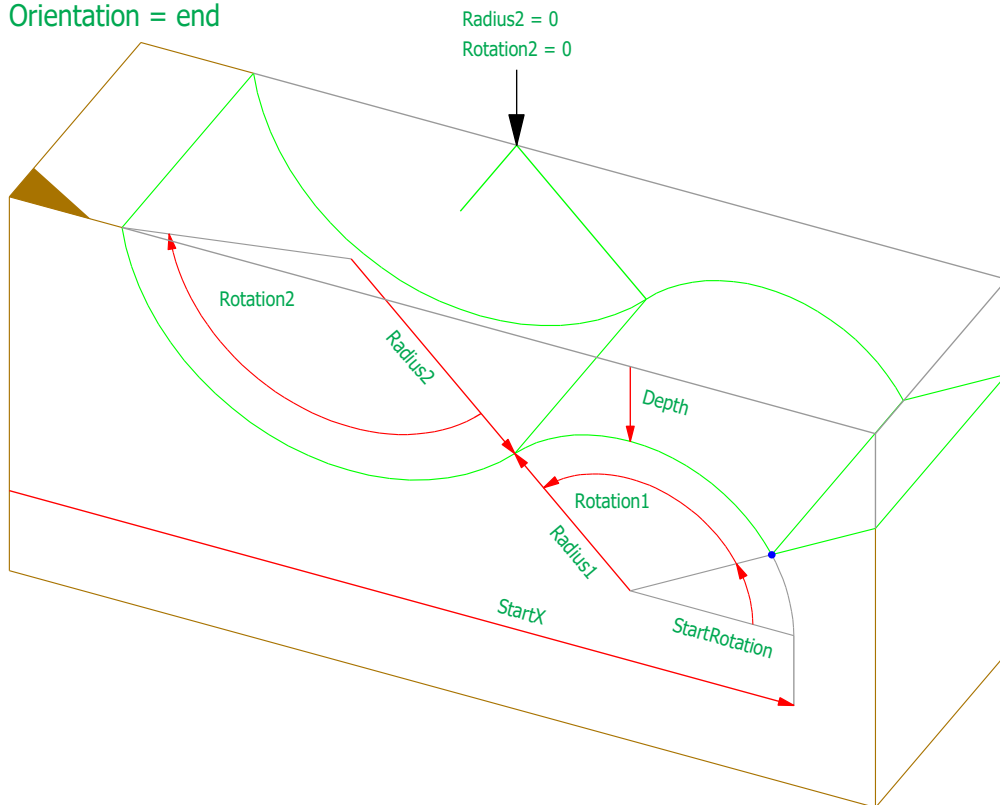



## Parameters ProfileFront

Name	Type	Default	Min	Max
Orientation	OrientationType		start	end
StartX	LengthPosType	0.0	-100000.0	100000.0
ArcShape	ArcShapeType	convex		
Depth	LengthSType	0.0	0.0	1000.0
StartRotation	Inclination2Type	0.0	-90.0	90.0
Rotation1	Angle2Type	90.0	0.0	180.0
Radius1	LengthSType	250.0	0.0	1000.0
Rotation2	Angle2Type	90.0	0.0	180.0
Radius2	LengthSType	250.0	0.0	1000.0

ProfileCambered

Orientation = start

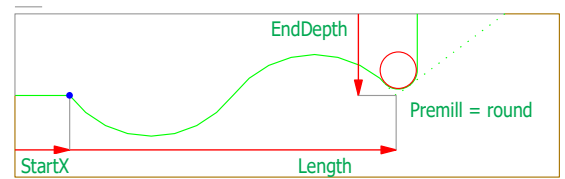
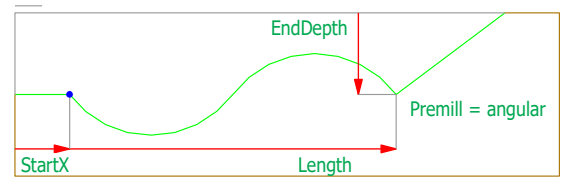
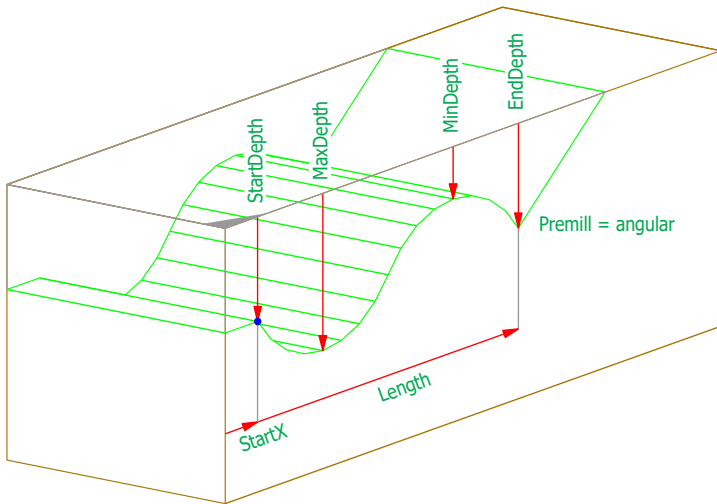

Orientation = end

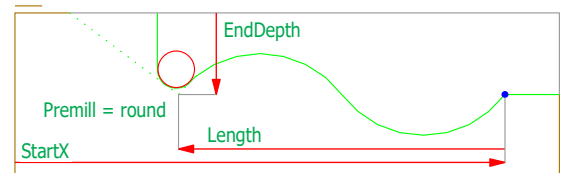
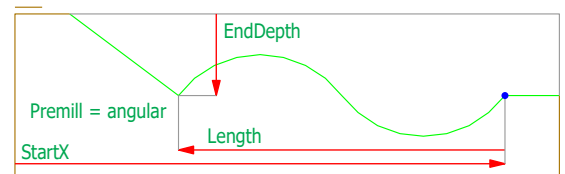
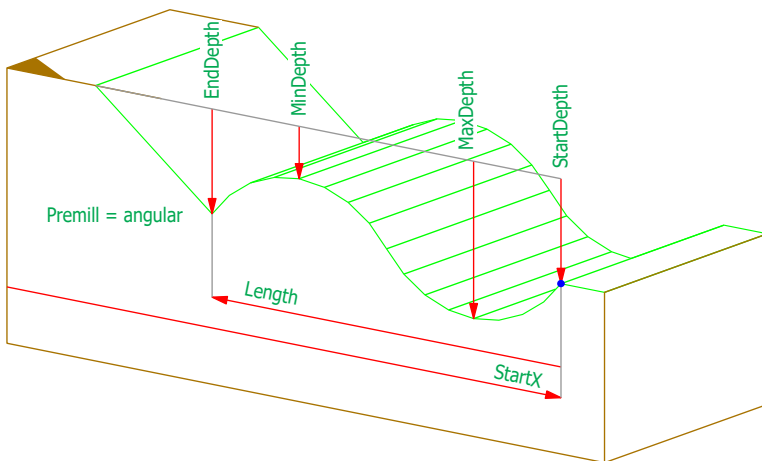

The curve is defined by a cubic polynomial.

$$Y = Ax^3 + Bx^2 + Cx + D$$

The coefficients A, B, C and D must be calculated on the machine side.

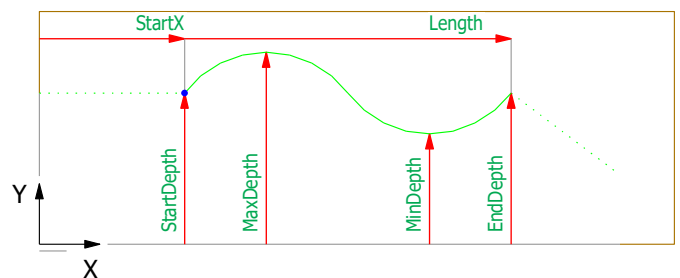

## Parameters ProfileCambered

Name	Type	Default	Min	Max
Orientation	OrientationType		start	end
StartX	LengthPosType	0.0	-100000.0	100000.0
Length	LengthType	0.0	0.0	100000.0
StartDepth	LengthSType	40.0	0.0	1000.0
MaxDepth	LengthSType	60.0	0.0	1000.0
MinDepth	LengthSType	10.0	0.0	1000.0
EndDepth	LengthSType	40.0	0.0	1000.0
Premill	PremillType	angular	round/angular	

### RoundArch

ArcShape = concave

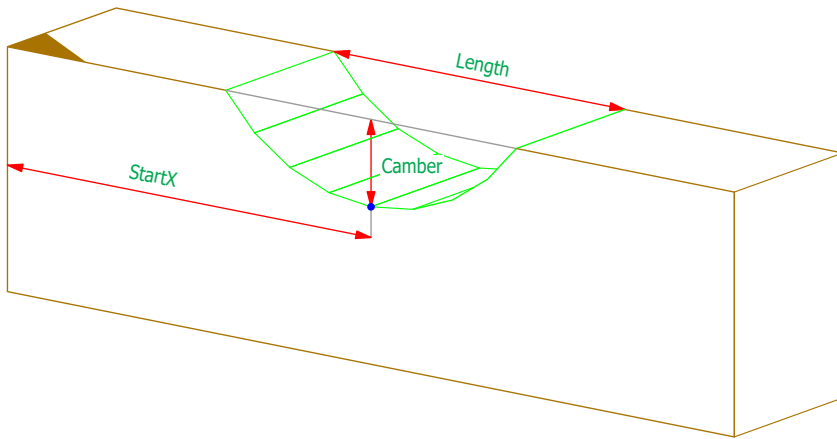

ArcShape = convex

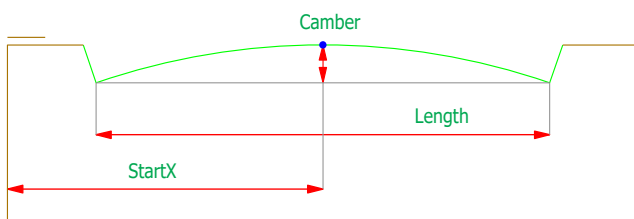

## Parameters RoundArch

Name	Type	Default	Min	Max
StartX	LengthPosType	0.0	-100000.0	100000.0
Length	LengthType	500.0	0.0	100000.0
Camber	LengthSType	30.0	0.0	1000.0
ArcShape	ArcShapeType	concave		
Premill	PremillType	angular	round/angular	

### ProfileHead

Orientation = start

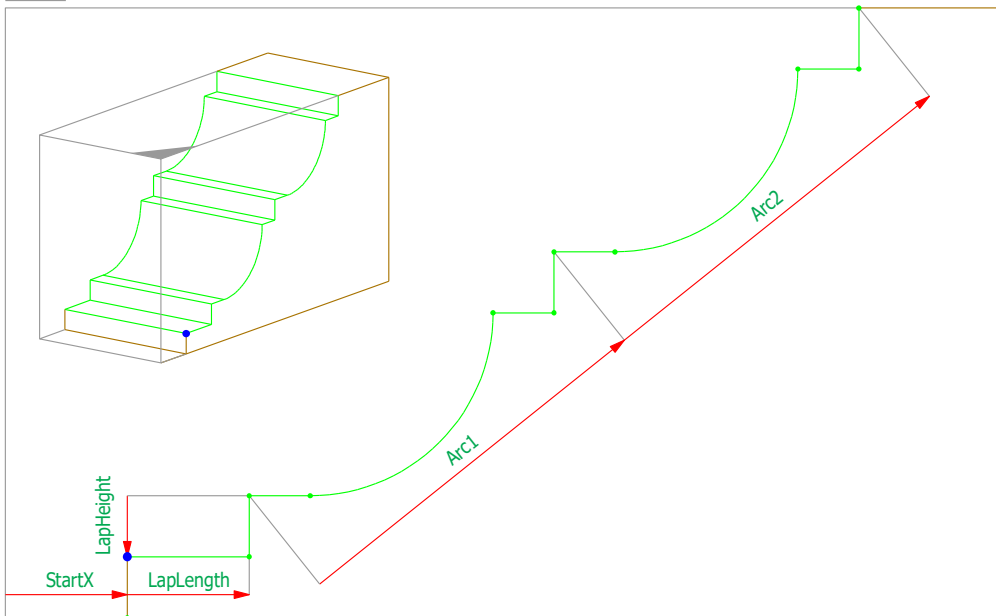

Orientation = end

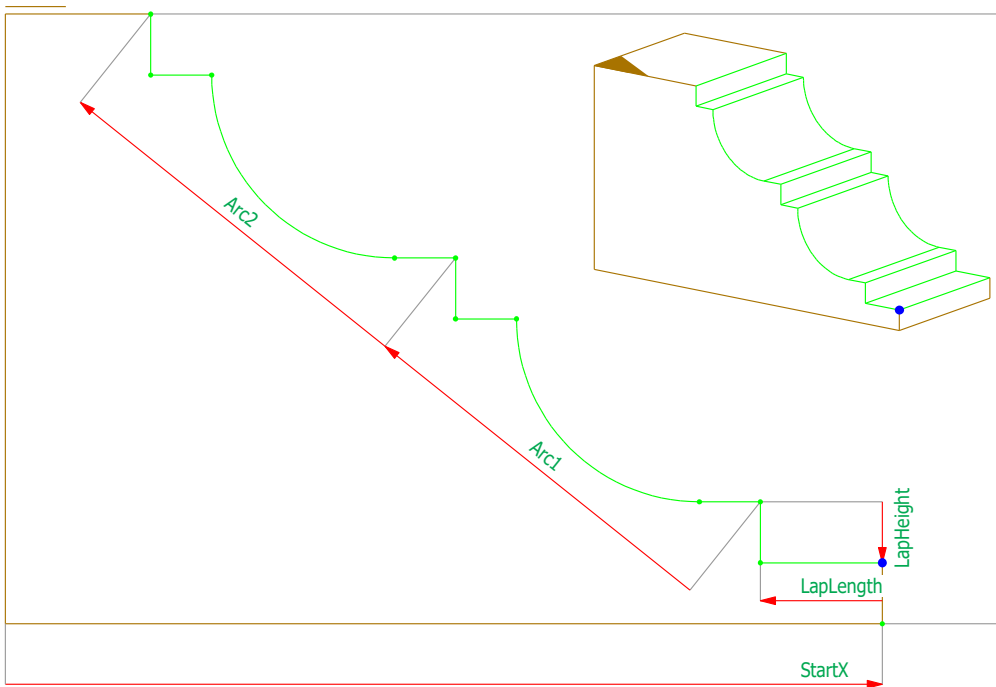

Parameters ProfileHead

Name	Type	Default	Min	Max
Orientation	OrientationType		start	end
StartX	LengthPosType	0.0	-100000.0	100000.0
Arc2	ProfileArcType			
LapLength	LengthSType	10.0	0.0	1000.0
LapHeight	LengthSType	10.0	0.0	1000.0

ProfileArcType

ArcShape	ArcShapeType	QuarterArc convex	QuarterArc/Segment convex/concave	
LapLength	LengthSType	10.0	0.0	1000.0
LapHeight	LengthSType	10.0	0.0	1000.0
Displacement	LengthSType	10.0	0.0	1000.0

QuarterArc

Radius	LengthSType	50.0	0.0	1000.0
--------	-------------	------	-----	--------

Segment

Length	LengthSType	50.0	0.0	1000.0
Height	LengthSType	50.0	0.0	1000.0
Camber	LengthSType	50.0	0.0	1000.0

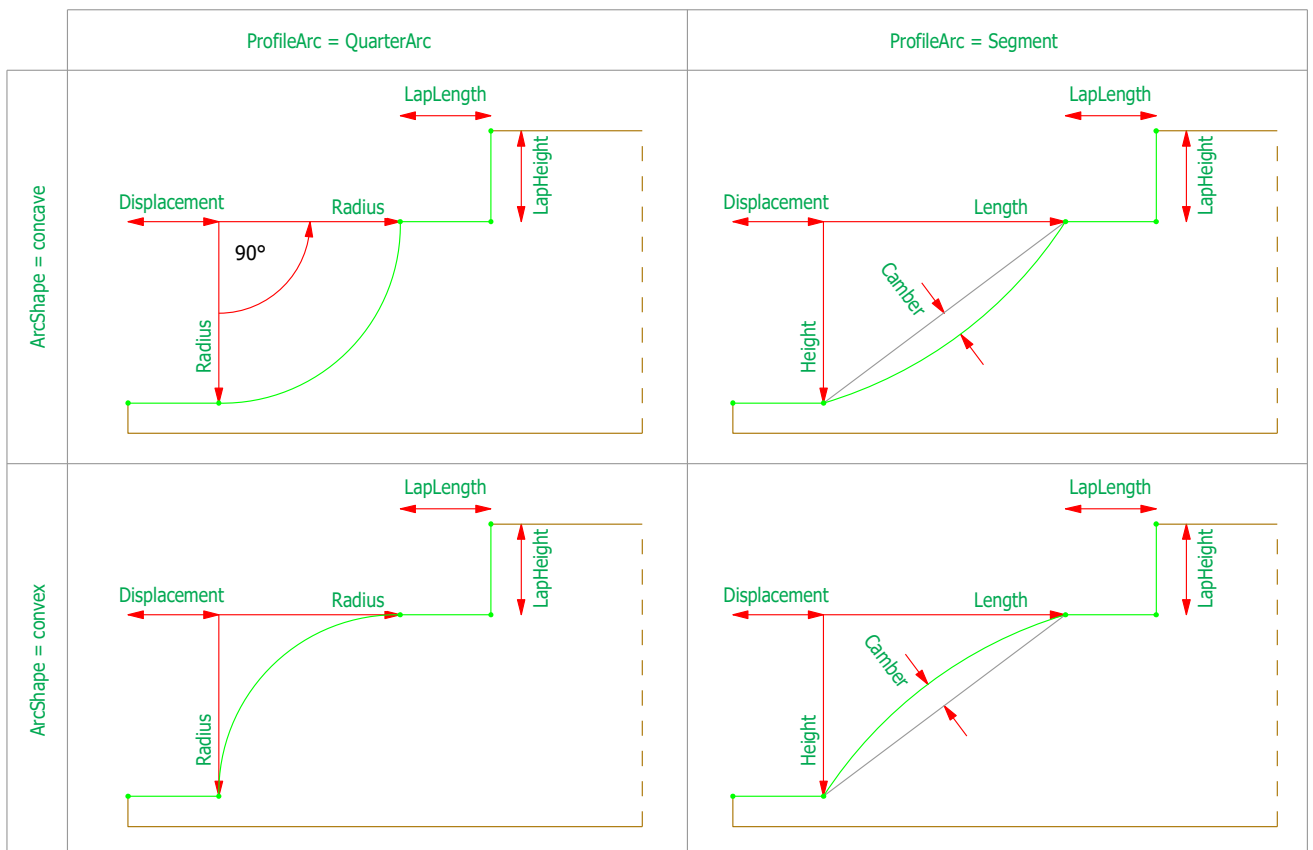

### Sphere

Orientation = start

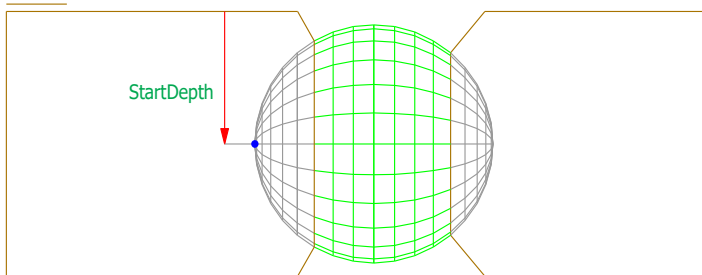
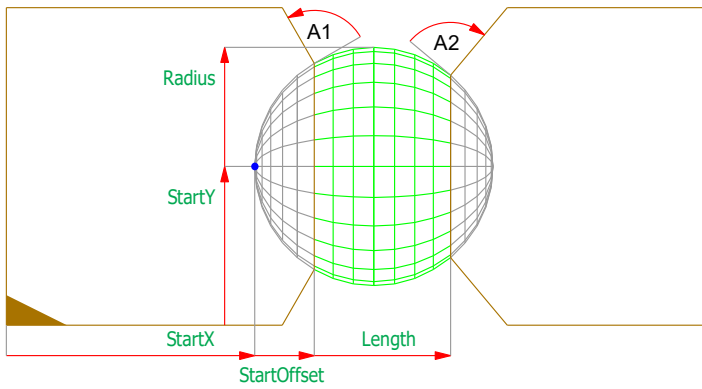

Orientation = end

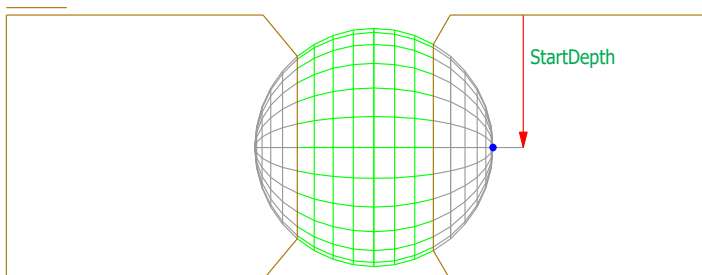
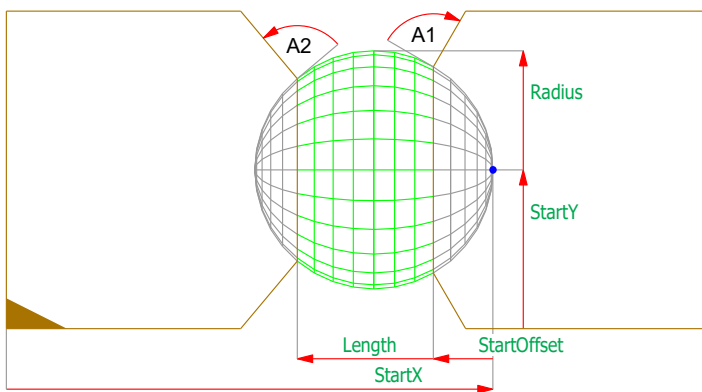

A1 and A2 are defined on the machine side. They depend on the capabilities of the machine. In this pictures A1 and A2 are 90°.

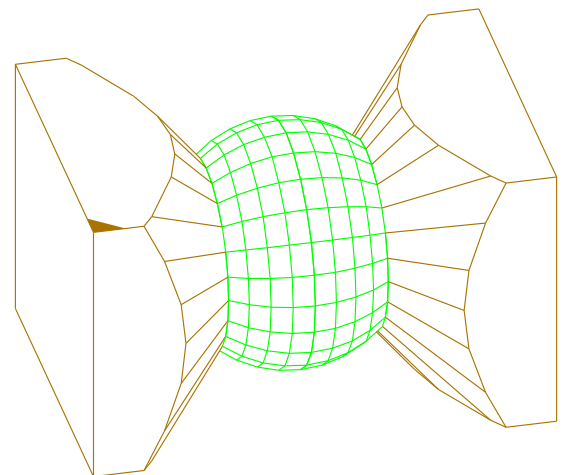



## Parameters Sphere

Name	Type	Default	Min	Max
Orientation	OrientationType		start	end
StartX	LengthPosType	0.0	-100000.0	100000.0
StartY	WidthNType	60.0	-50000.0	50000.0
StartDepth	WidthNType	60.0	-50000.0	50000.0
Length	WidthType	50.0	0.0	50000.0
Radius	WidthType	50.0	0.0	50000.0
StartOffset	WidthType	0.0	0.0	50000.0

### TriangleCut

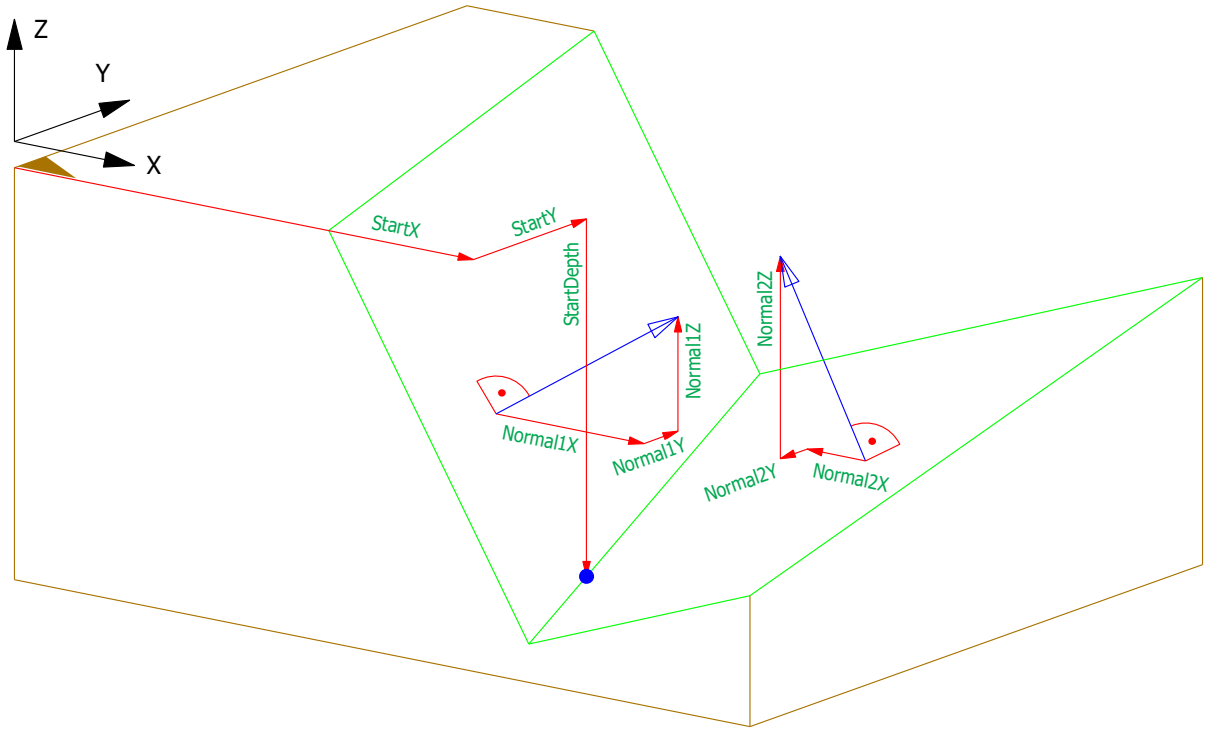

## Parameters TriangleCut

Name	Type	Default	Min	Max
StartX	LengthPosType	0.0	-100000.0	100000.0
StartY	WidthNType	60.0	-50000.0	50000.0
StartDepth	WidthNType	60.0	-50000.0	50000.0
Normal1X	WidthNType	1.0	-50000.0	50000.0
Normal1Y	WidthNType	0.0	-50000.0	50000.0
Normal1Z	WidthNType	0.0	-50000.0	50000.0
Normal2X	WidthNType	1.0	-50000.0	50000.0
Normal2Y	WidthNType	0.0	-50000.0	50000.0
Normal2Z	WidthNType	0.0	-50000.0	50000.0

### TyroleanDovetail

Orientation = start

LapPosition = refedge

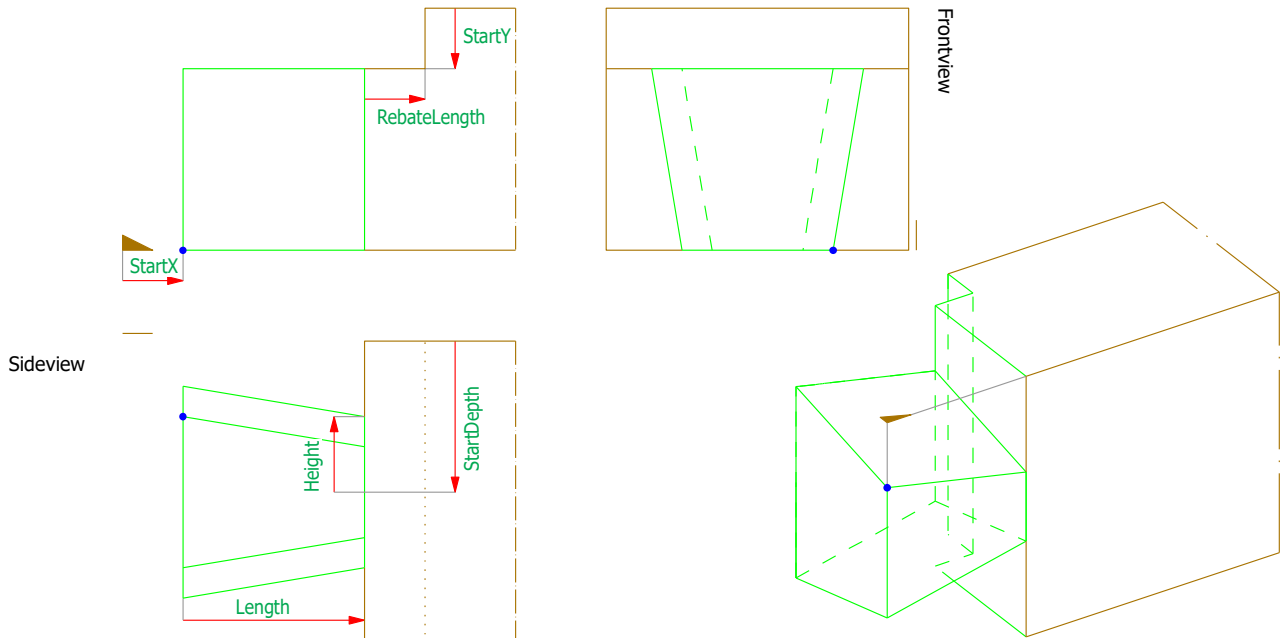

LapPosition = oppedge

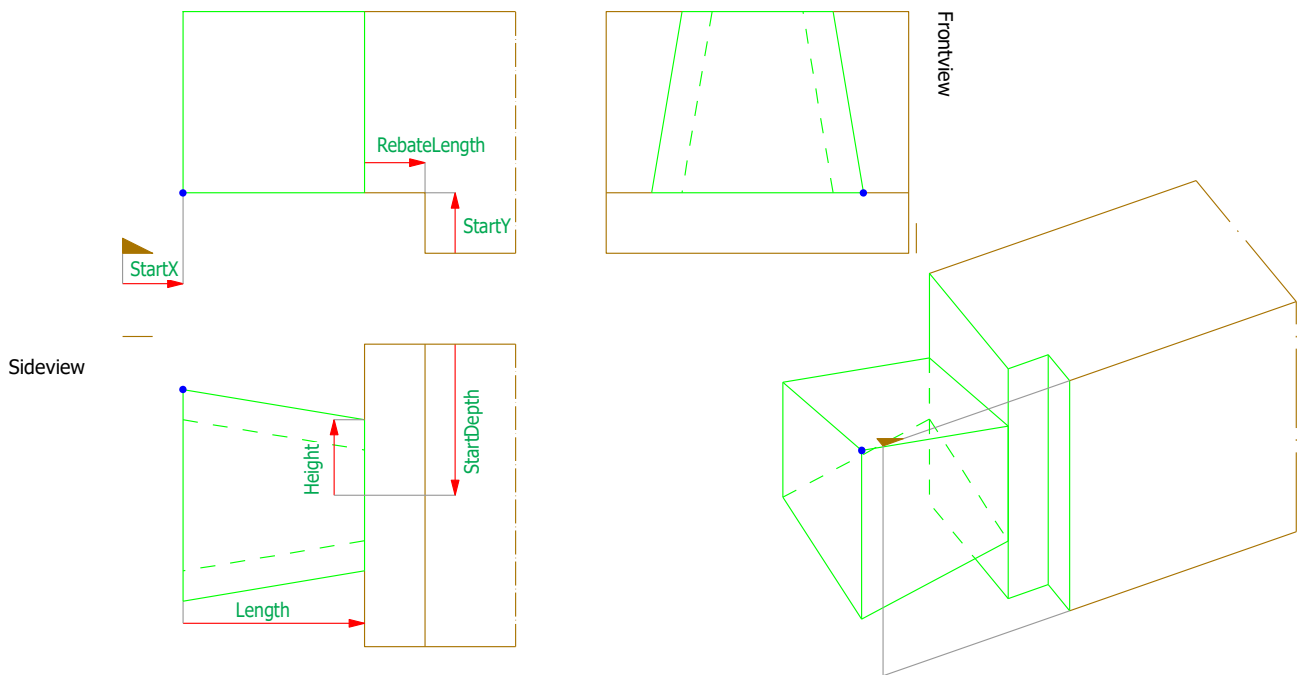

CutOff = yes

This processing trims the part, even it is on a ReferencePlane

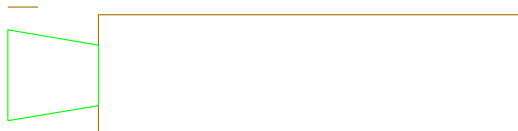

CutOff = no

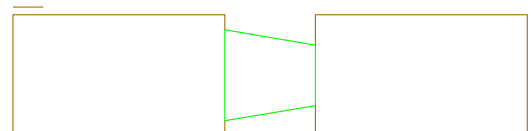

TyroleanDovetail

Orientation = start

LapPosition = refedge

LapPosition = oppedge

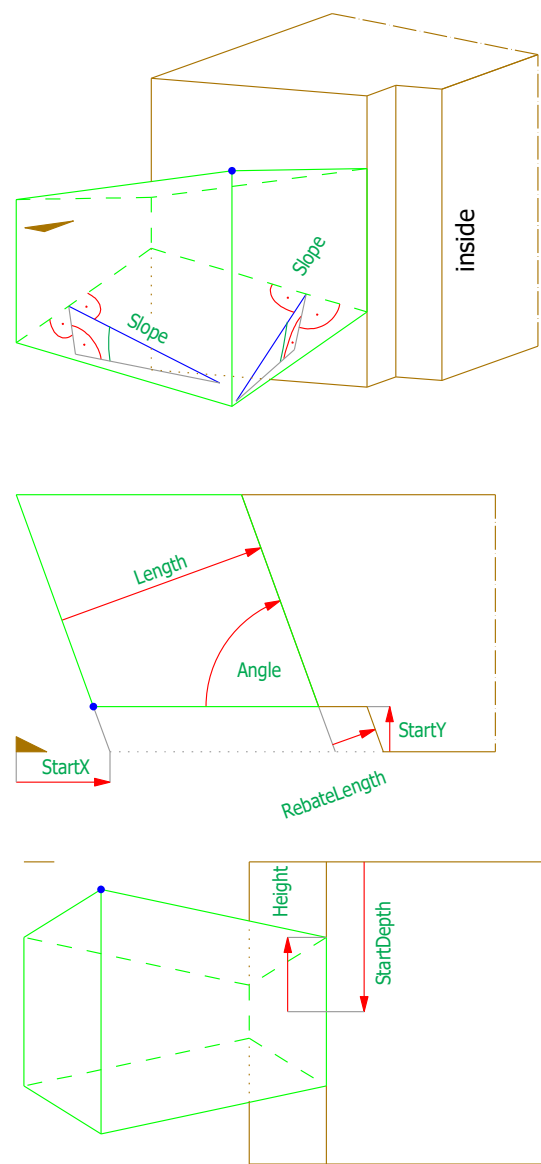
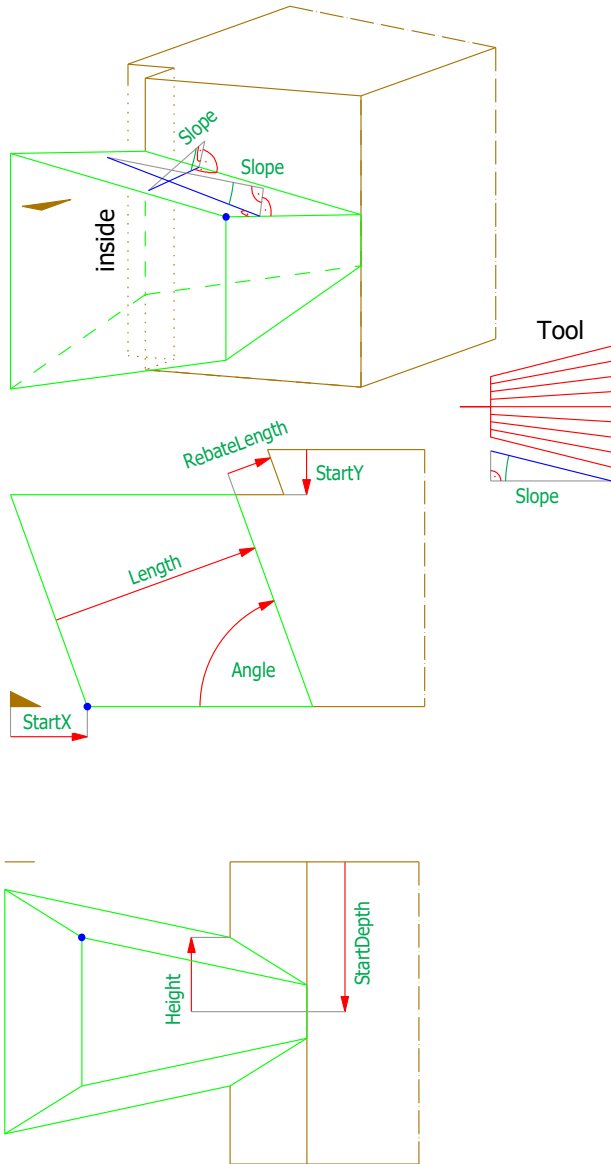

LapExit = none

LapExit = mitre

LapExit = rebate

LapExit = none

LapExit = mitre

LapExit = rebate

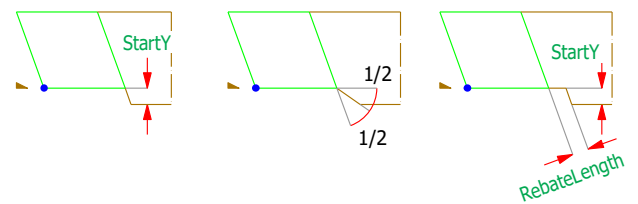
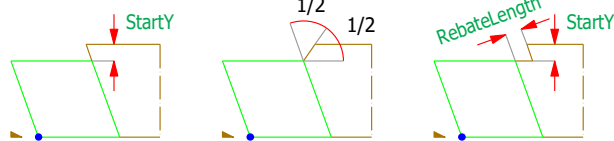

### TyroleanDovetail

Orientation = start

LapPosition = refedge

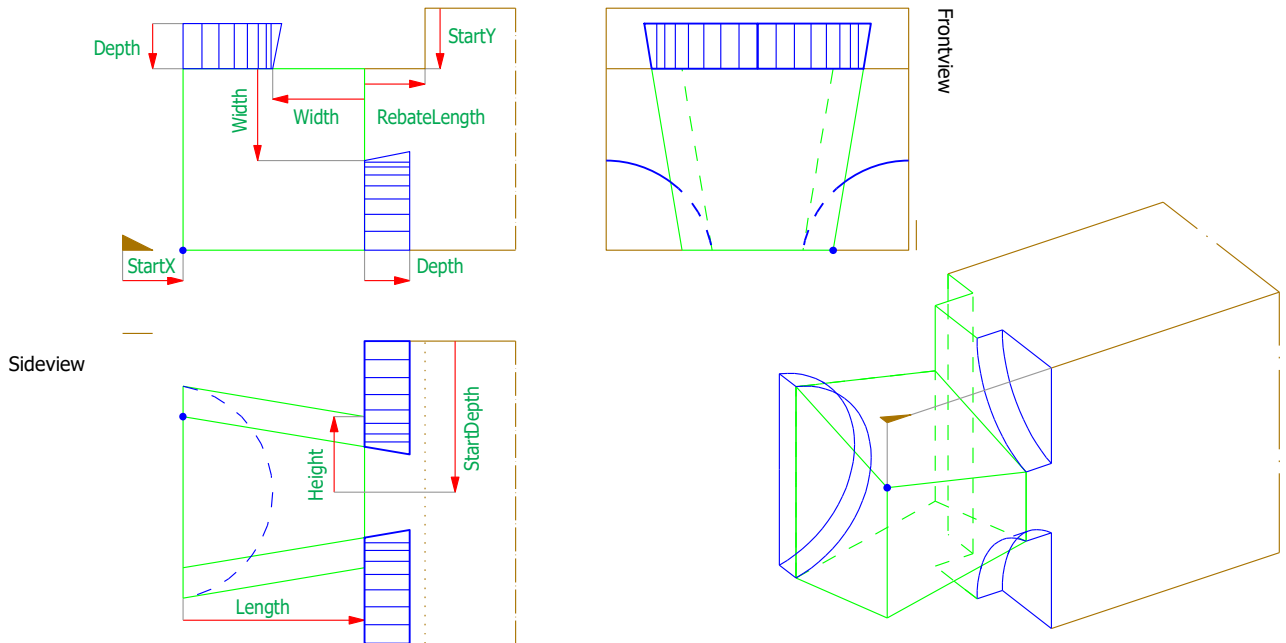

LapPosition = oppedge

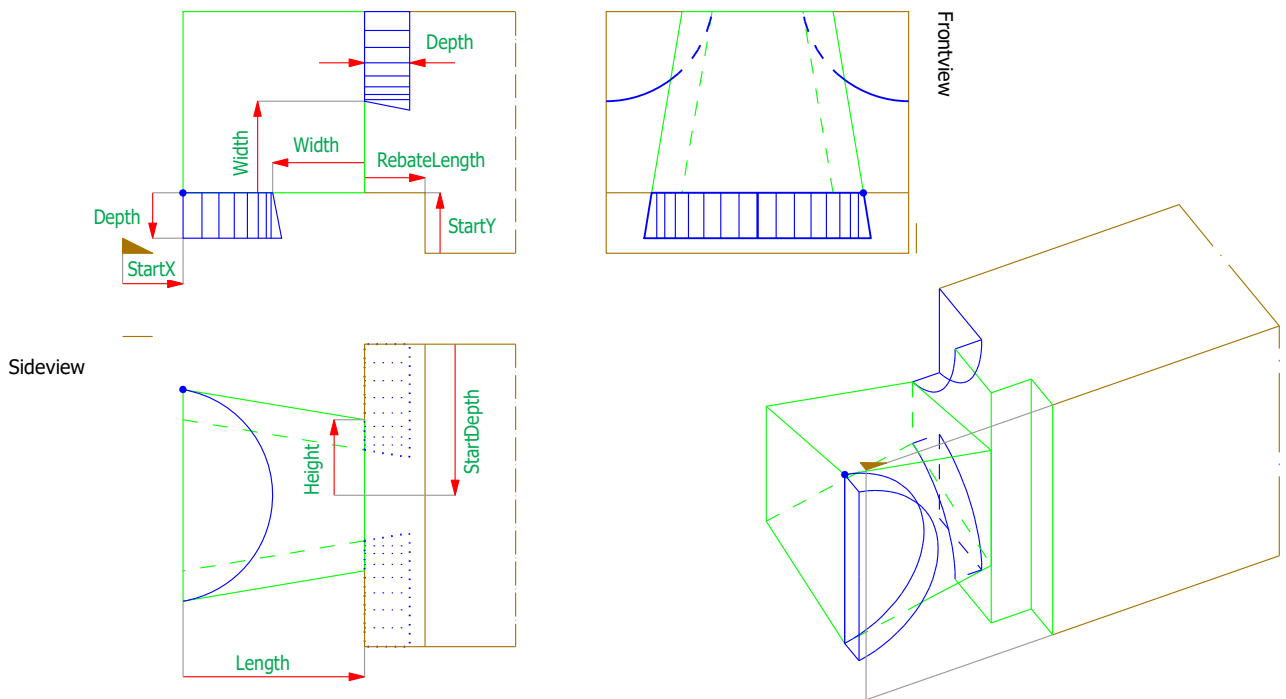

TyroleanDovetail

Orientation = start

LapPosition = refedge

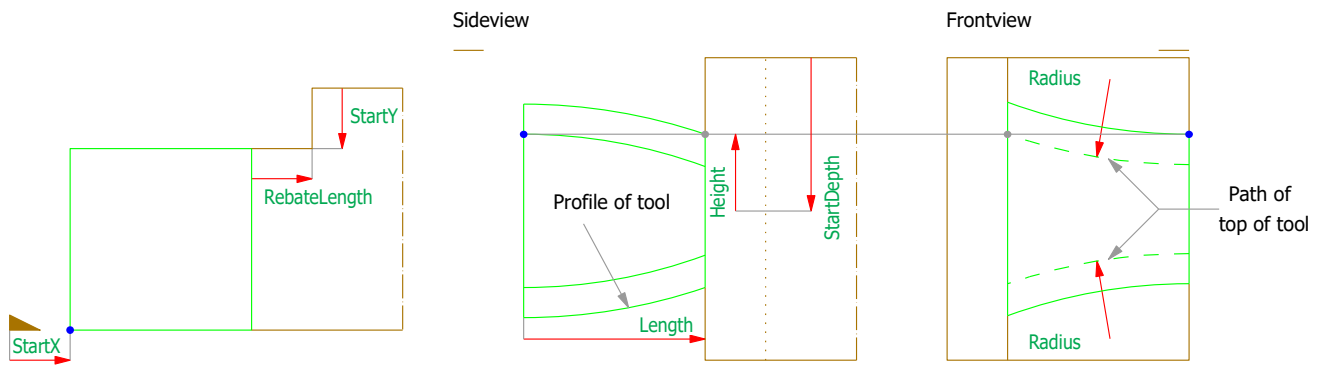

LapPosition = oppedge

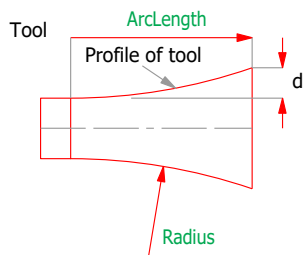
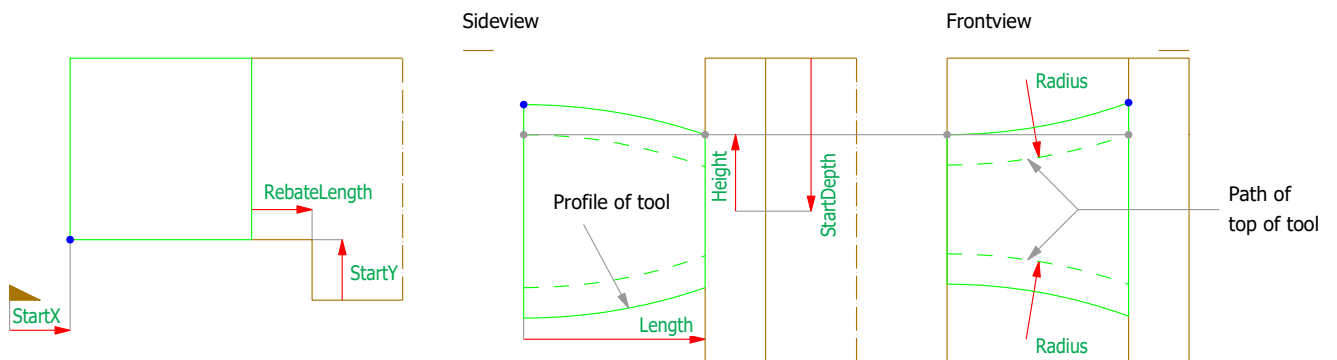

This processing trims the part, even it is on a ReferencePlane  
Examples:



### TyroleanDovetail

Orientation = end

CutOff = yes

LapPosition = refedge

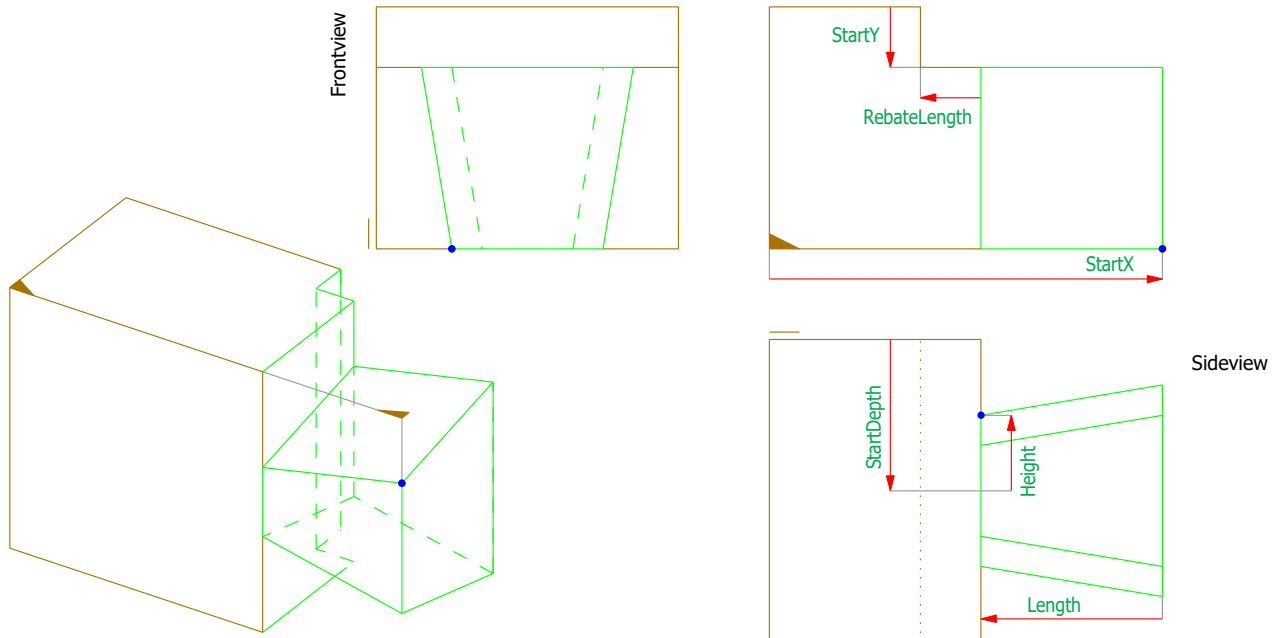

LapPosition = oppedge

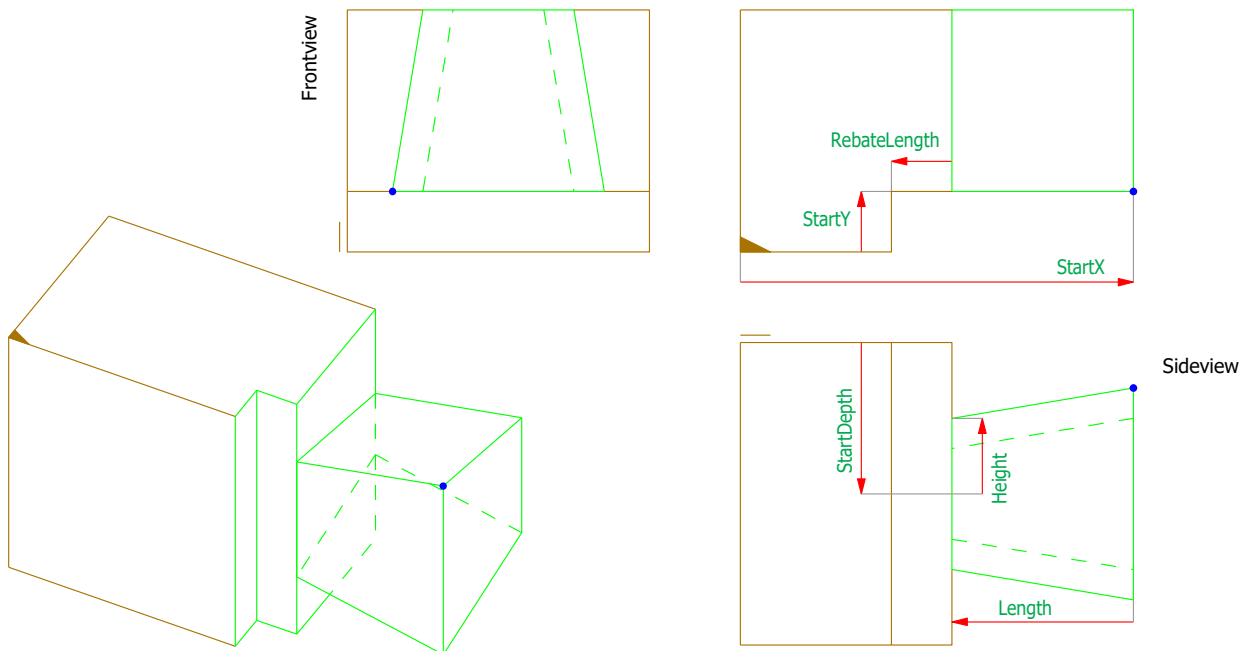

CutOff = yes

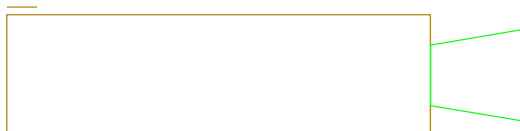

CutOff = no

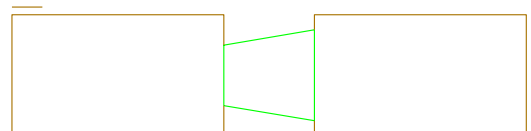



TyroleanDovetail

Orientation = end

LapPosition = refedge

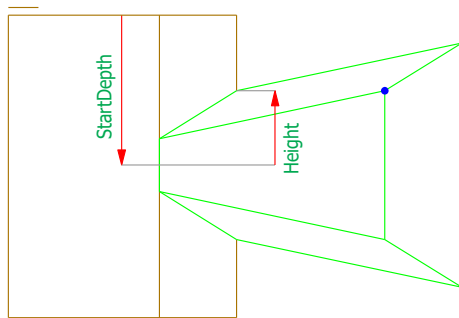
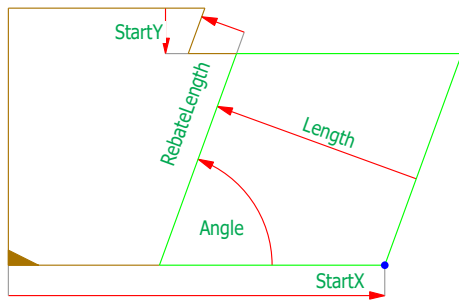
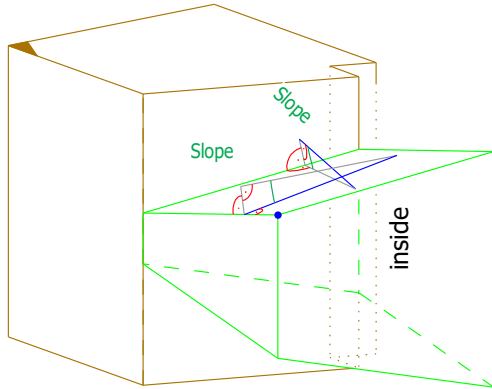

LapExit = none

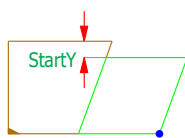

LapExit = mitre

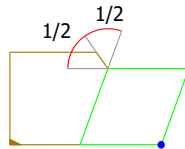

LapExit = rebate

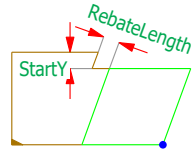

LapPosition = oppedge

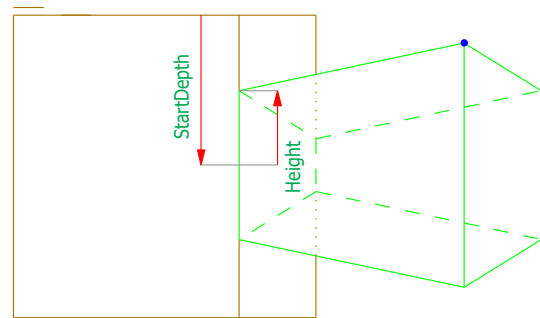
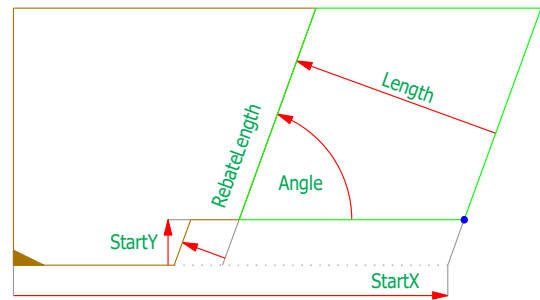
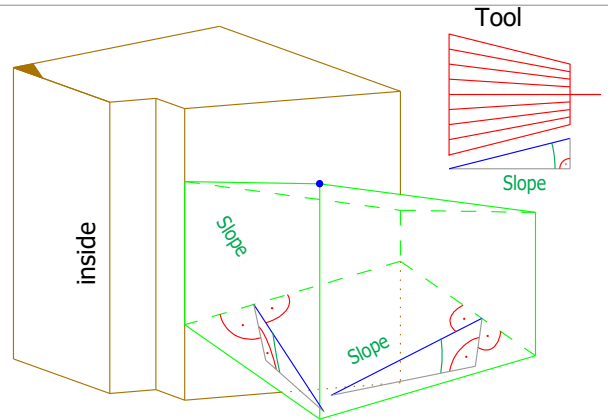

LapExit = none

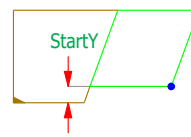

LapExit = mitre

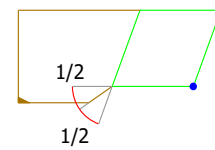

LapExit = rebate

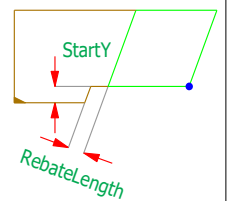

### TyroleanDovetail

Orientation = end

LapPosition = refedge

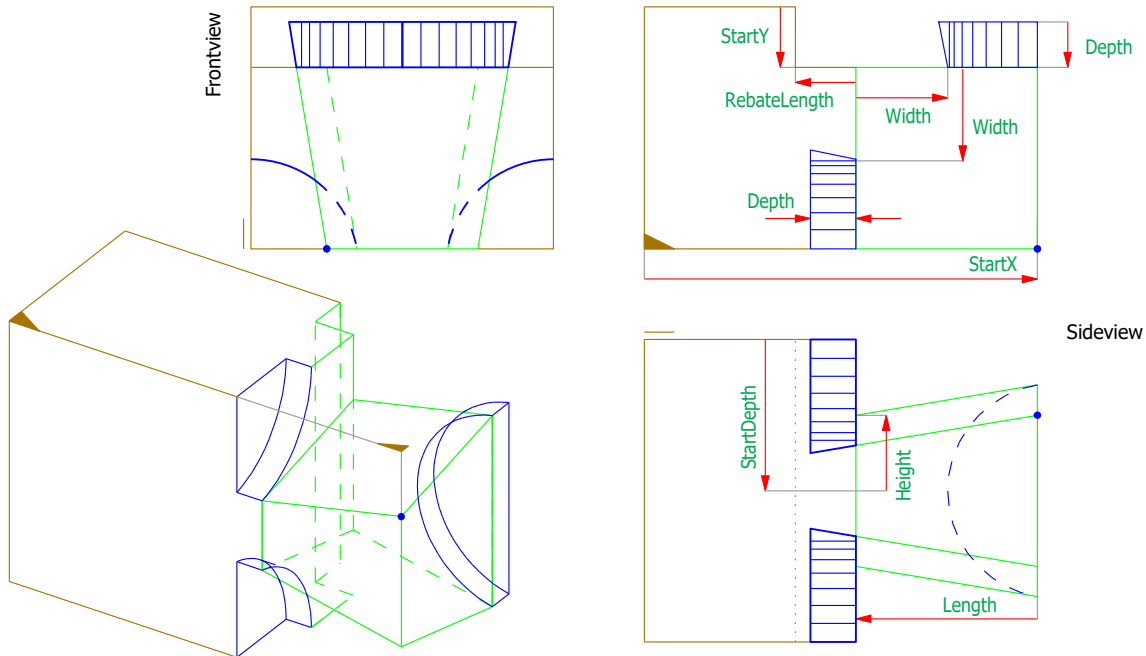

LapPosition = oppedge

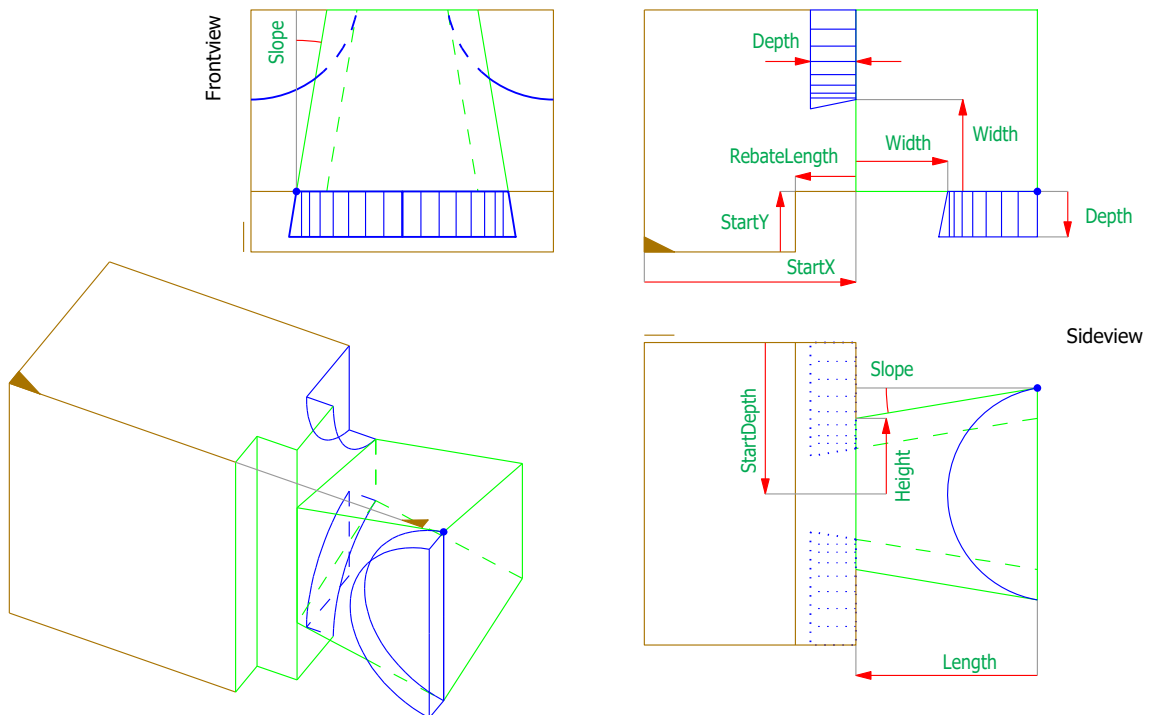

### TyroleanDovetail

Orientation = end

LapPosition = refedge

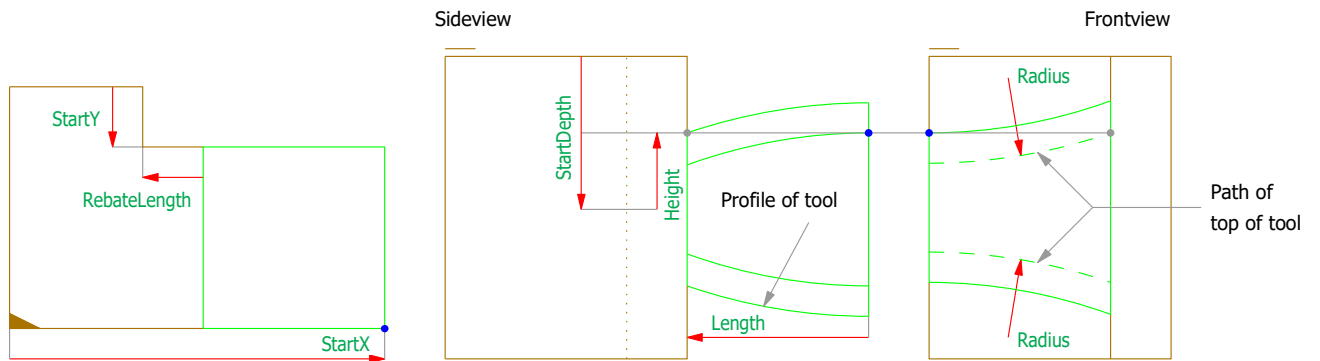

LapPosition = oppedge

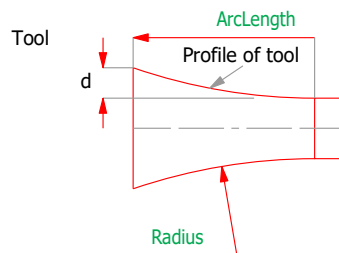
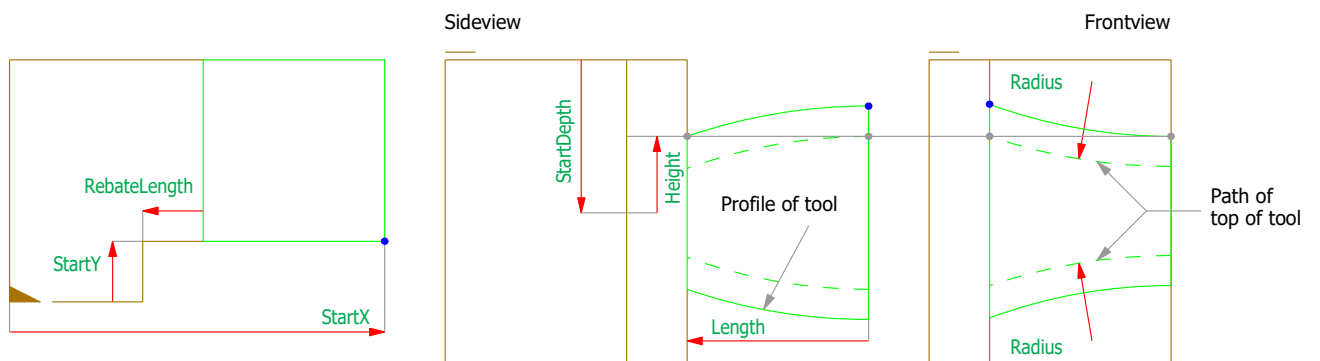

## Parameters TyroleanDovetail

Name	Type	Default	Min	Max
Orientation	OrientationType		start	end
CutOff	BooleanType	no	no	yes
StartX	LengthPosType	0.0	-100000.0	100000.0
StartY	WidthType	30.0	0.0	50000.0
StartDepth	WidthNType	50.0	-50000.0	50000.0
Angle	AngleType		0.1	179.9
Slope	double		0.0	45.0
Length	WidthType	150.0	0.0	50000.0
RebateLength	WidthType	10.0	0.0	50000.0
Height	WidthType	60	0.0	50000.0
LapPosition	EdgePositionType	refedge	refedge/oppedge	
LapExit	LapExitType	mitre	none/mitre/rebate	
Shape	TyroleanDovetailShapeType	angular	angular/straight	
ProcessSide	ProcessSideType	both	both/refside/oppside	

## Frosch

Name	Type	Default	Min	Max
Width	WidthType			
Depth	WidthType			

## Klingschrot

Name	Type	Default	Min	Max
Radius	WidthType			
ArcLength	WidthType			

Dovetail

Orientation = start

	LapPosition = refedge	LapPosition = oppedge
Shape = european		
Shape = american		
LapExit	<p>LapExit = none</p> <p>LapExit = mitre</p> <p>LapExit = rebate</p>	<p>LapExit = none</p> <p>LapExit = mitre</p> <p>LapExit = rebate</p>

Dovetail

Orientation = end

	LapPosition = refedge	LapPosition = oppedge
Shape = european		
Shape = american		
LapExit	<p>LapExit = none</p> <p>LapExit = mitre</p> <p>LapExit = rebate</p>	<p>LapExit = none</p> <p>LapExit = mitre</p> <p>LapExit = rebate</p>

Dovetail

Name	Type	Default	Min	Max
Orientation	OrientationType		start	end
CutOff	BooleanType	no	no	yes
StartX	LengthPosType	0.0	-100000.0	100000.0
StartY	WidthType	30.0	0.0	50000.0
StartDepth	WidthNType	50.0	-50000.0	50000.0
Slope	double		0.0	45.0
Length	WidthType	150.0	0.0	50000.0
RebateLength	WidthType	10.0	0.0	50000.0
HeightRefSide	WidthType	60	0.0	50000.0
HeightOppSide	WidthType	30.0	0.0	50000.0
LapPosition	EdgePositionType	refedge	refedge/oppedge	
LapExit	LapExitType	mitre	none/mitre/rebate	
Shape	DovetailShapeType	european	european/american	
ProcessSide	ProcessSideType	both	both/refside/oppside	

ProcessSide = both

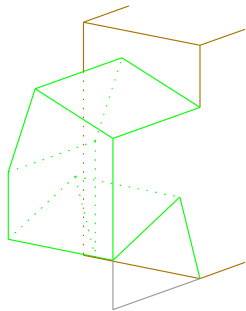

ProcessSide = refside

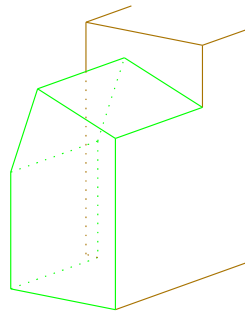

ProcessSide = oppside

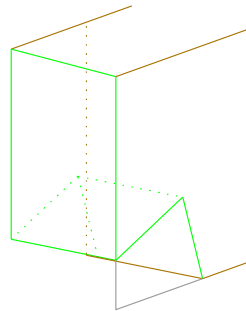

This processing trims the part, even it is on a ReferencePlane

Examples:

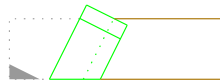
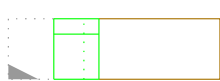

### Contour, some definitions

The descriptions on the following sides show some special definitions and additional parameters, which appear around the topic contour, outline, aperture, etc.

#### Contour

The elements of a SimpleContour are a Startpoint and a list of Lines and Arcs.

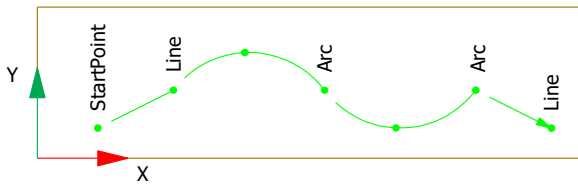
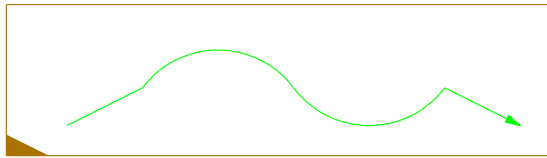

Name	Type
StartPoint	PointType
Line	LineType
Arc	Arctype

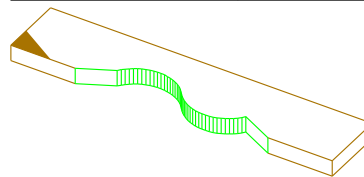

#### Circle

A circle must be defined with 2 arcs a 180 degrees.

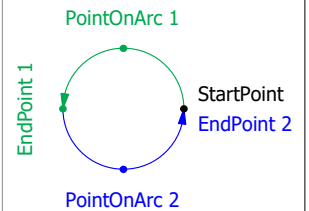

#### Parameter: ToolPosition

Toolposition = center

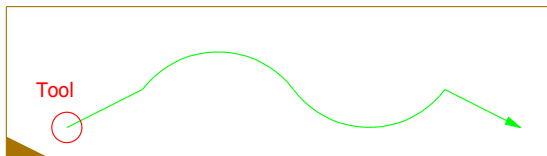

Toolposition = left

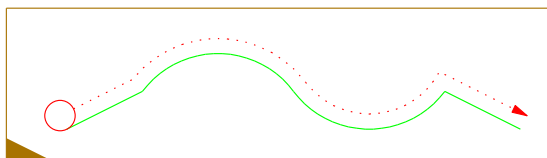

Toolposition = right

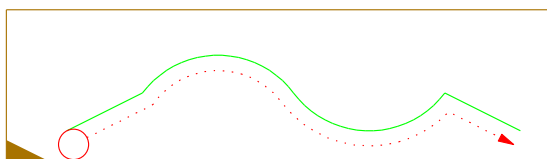

#### Depth and DepthBounded

Example:  $H = 280$   
 $StartPoint.z = 70$

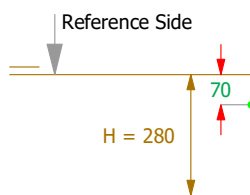

Effective Depth

		Depth in BTLx File		
		Depth = 0 or not set	Depth = 210	Depth = 140
DepthBounded in BTLx File	DepthBounded = NO or not set			
	DepthBounded = YES			



### Face limited top or Bottom

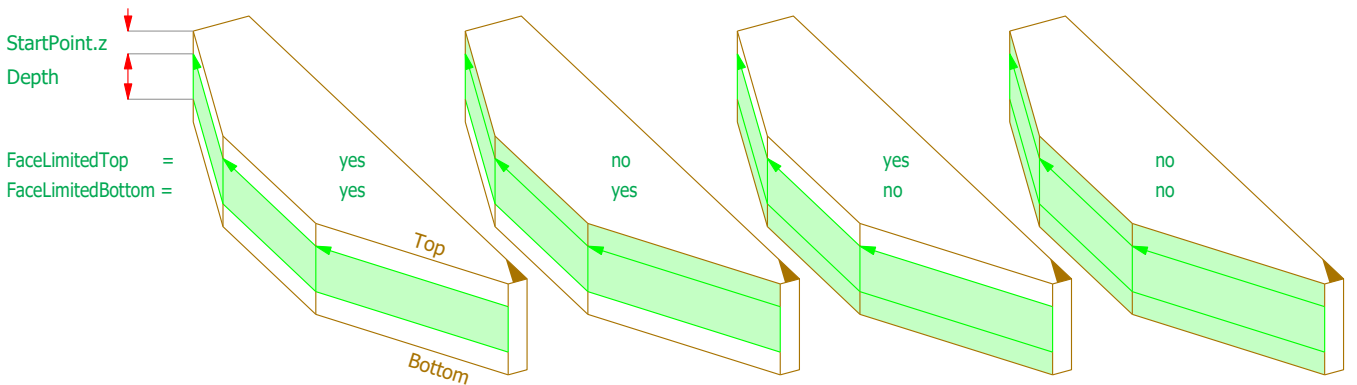

### Inclination

In this view the contour is oriented away from the observer.

Toolposition = left or center

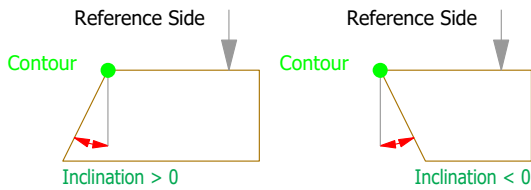

Toolposition = right

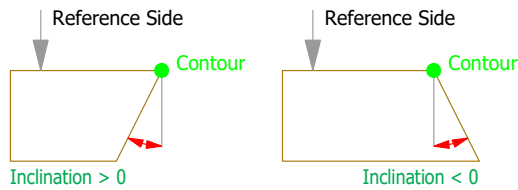

The inclination is constant over the length of the segment and is always measured from the tangent of the contour at the actual point.

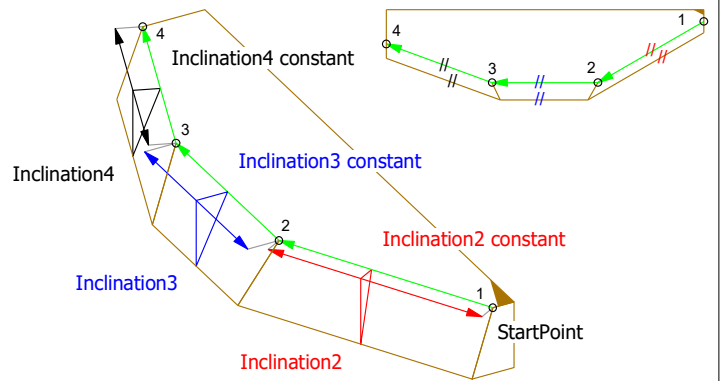

### DualContour

Name	Type
PrincipalContour	SimpleContourType
AssociatedContour	SimpleContourType

The PrincipalContour and the AssociatedContour must have the same number of points. The lines between the points on the PrincipalContour and the associated points on the AssociatedContour should not cross each other.

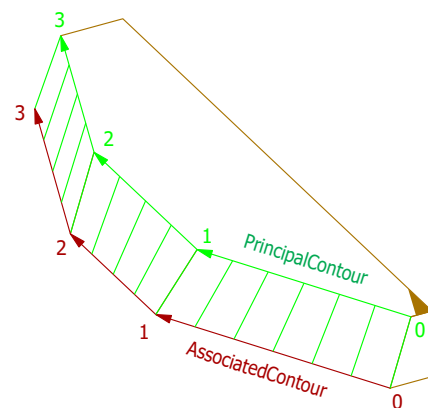

### FaceLimited

Attribute in SawContourAttributes

Example:  
One segment has attribute FaceLimited=no.

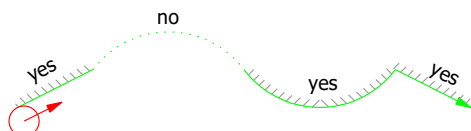

FaceLimited = no = Edge is destructible  
Attribute FaceLimited is available for:

- FreeContourType
- SawContourType
- MillContourType

Two of possible procedures on machine side

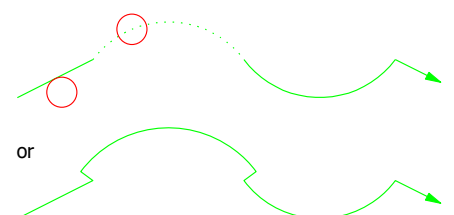

### NURBS / NURBSCurveType

A NURBSCurve, also called as spline, is defined with:

- ControlPoints
- Knots
- Degree

ControlPoints	List of points			
	Attributes of one point	Coordinates	X	Double
			Y	Double
		Weight	W	Double
Knots	List of values			
Degree	Degree of curve			

Example

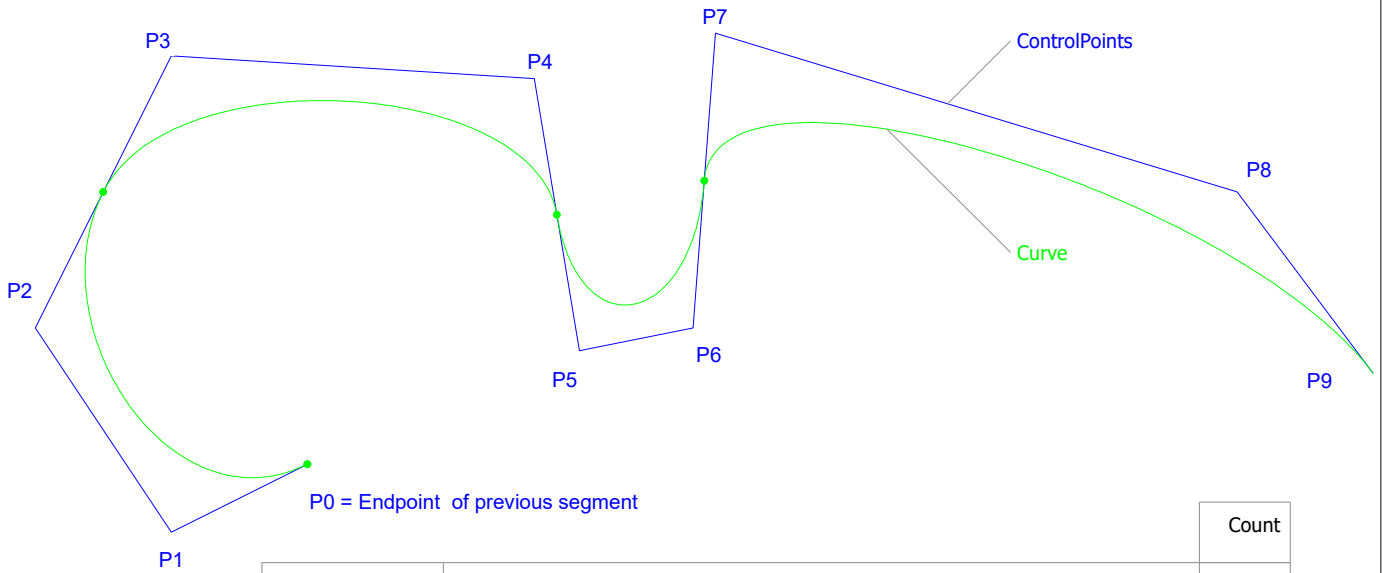

														Count
ControlPoints	P0	P1	P2	P3	P4	P5	P6	P7	P8	P9				10
Knots	0.0	0.0	0.0	1.0	1.0	2.0	2.0	3.0	3.0	4.0	4.0	4.0		12
Degree	3													

### FreeSurface

A NURBSPatch is defined with:

- ControlPoints
- KnotsU
- KnotsV
- DegreeU
- DegreeV
- CountU
- CountV

ControlPoints	List of points U and V			
	Attributes of one points	Coordinates	X	Double
			Y	Double
		Weight	W	Double
KnotsU	List of values			
KnotsV	List of values			
DegreeU	Degree of curve U			
DegreeV	Degree of curve U			
CountU	Count of ControlPoints U			
CountV	Count of ControlPoints V			

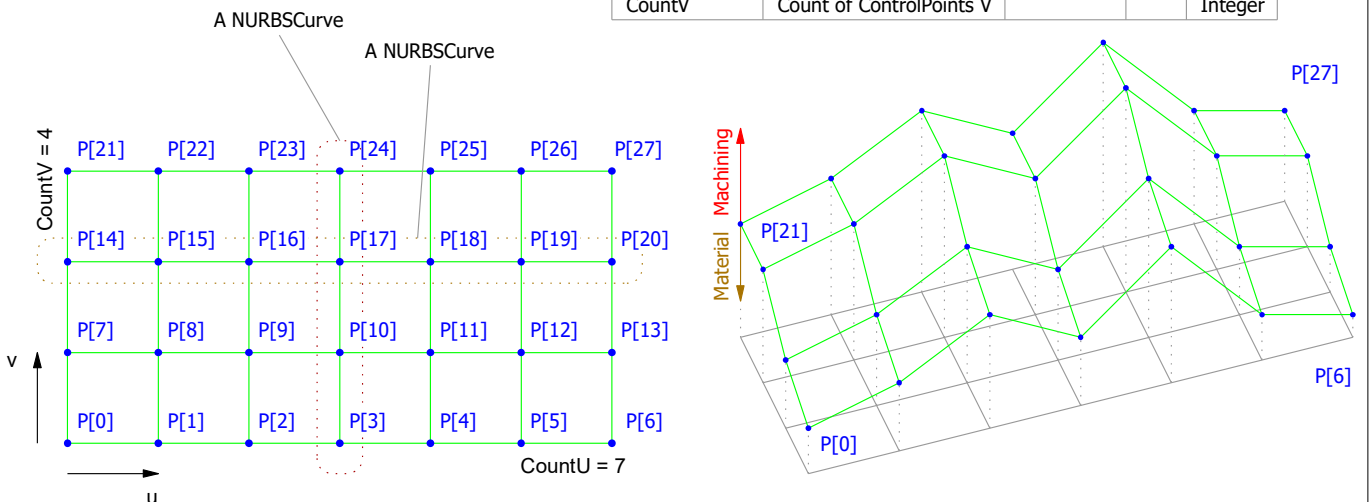

### FreeSurface

A NURBSPatch is defined with:

- ControlPoints
- KnotsU
- KnotsV
- DegreeU
- DegreeV
- CountU
- CountV

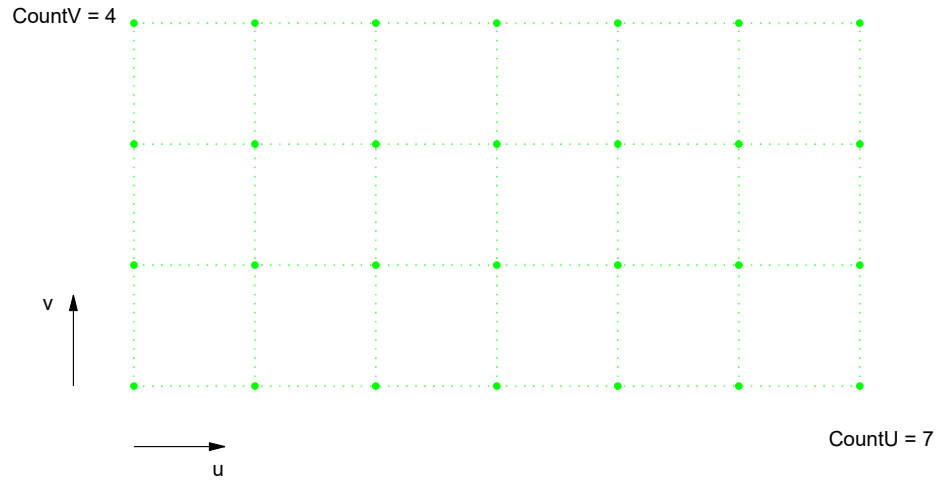

### ContourRecessType

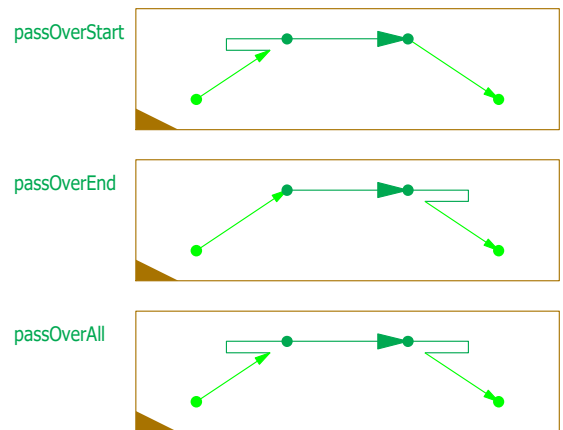
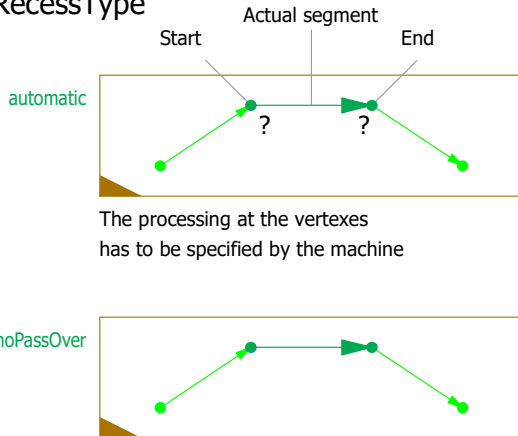

The machineside decides, how the RECESS is worked out. Examples:



Aperture

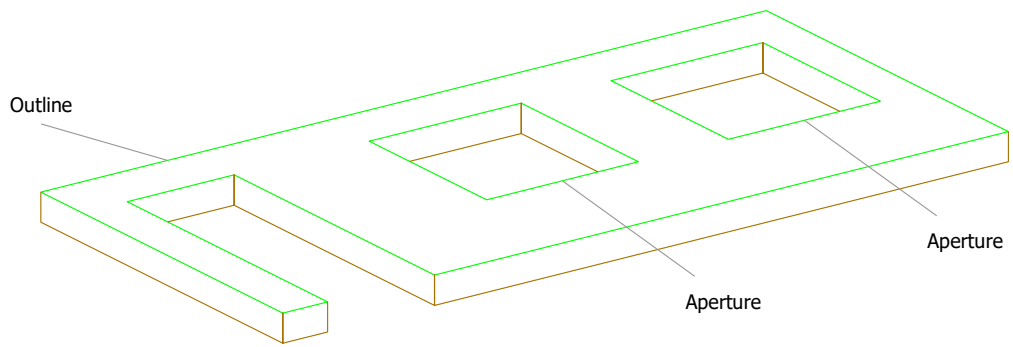

CounterSink

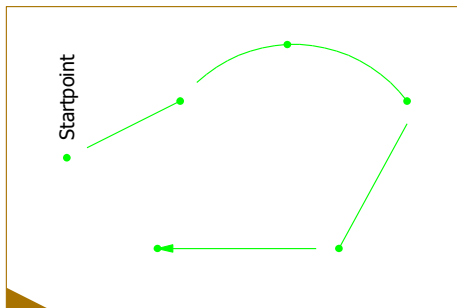

CounterSink = no

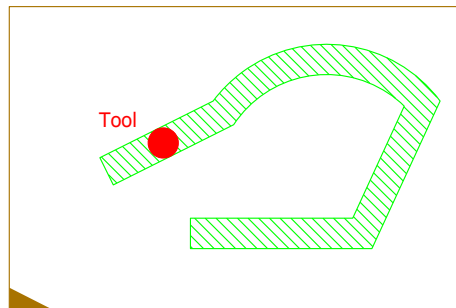

CounterSink = yes

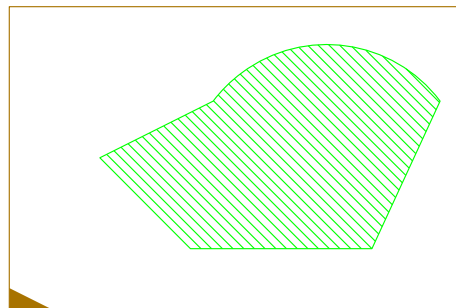

Contour -> CrampContourType -> CrampAngleRefType

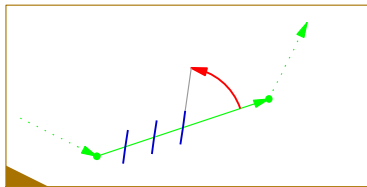

enumeration value = segment

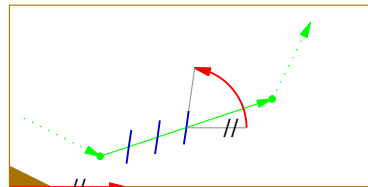

XVector enumeration value = part

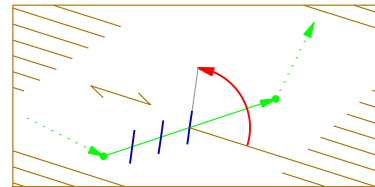

enumeration value = grain

Listing in the BTLX-File

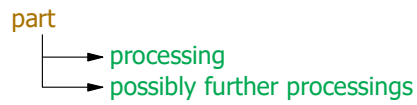
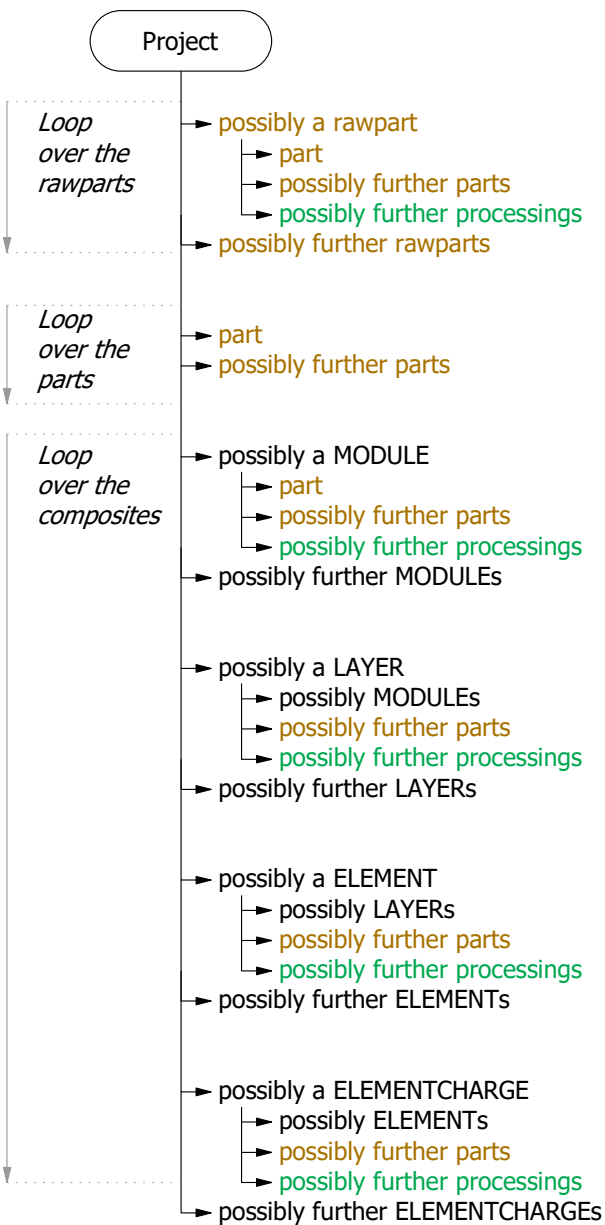

Hierarchical ordering

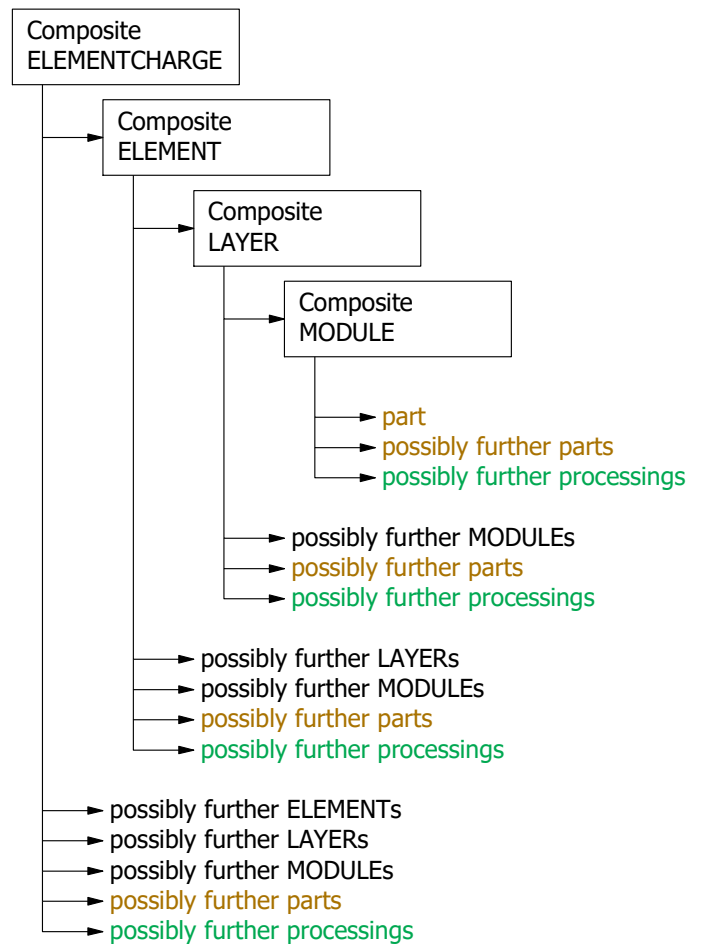

Example for a composite

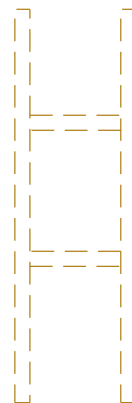
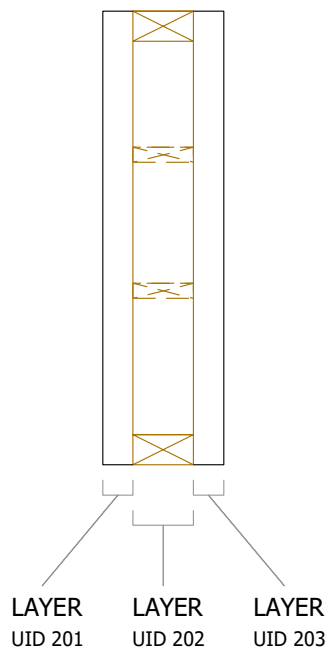
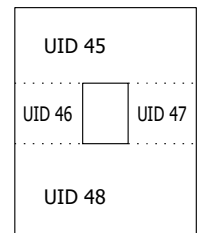
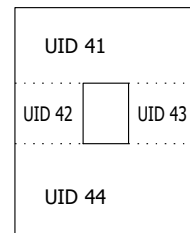
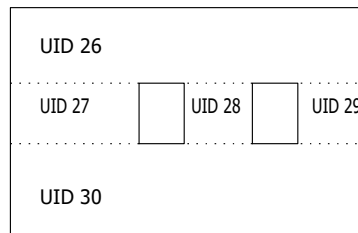
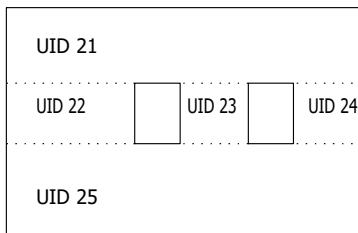
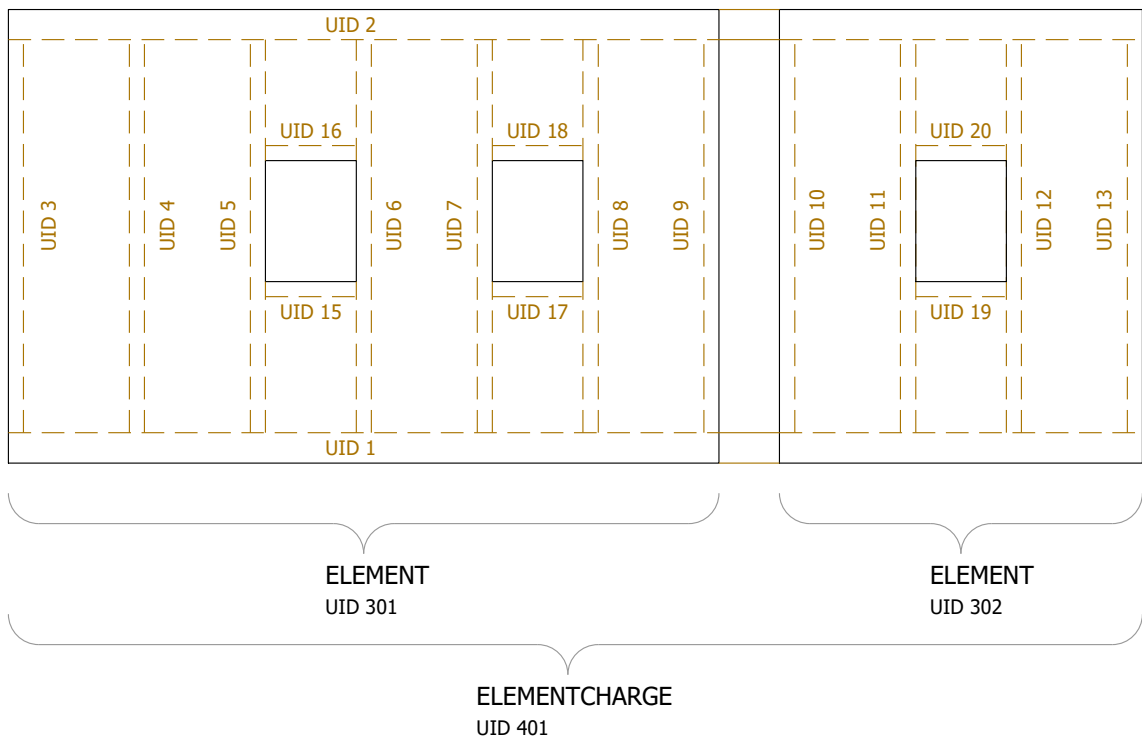

MODULE  
UID 101  
UID 102  
UID 103

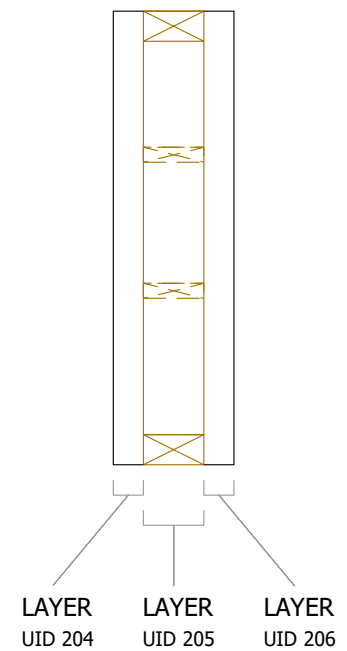

[PART]  
 UID: 1,2  
 processings ...  
 [PART]  
 UID: 3,4,5,6,7,8,9  
 UID: 10,11,12,13  
 processings ...  
 [PART]  
 UID: 15,16,17,18  
 processings ...

[PART]  
 UID: 21,26  
 processings ...  
 [PART]  
 UID: 22,27  
 processings ...  
 [PART]  
 UID: 23,28  
 processings ...  
 [PART]  
 UID: 24,29  
 processings ...  
 [PART]  
 UID: 25,30  
 processings ...

[PART]  
 UID: 41,45  
 processings ...  
 [PART]  
 UID: 42,46  
 processings ...  
 [PART]  
 UID: 43,47  
 processings ...  
 [PART]  
 UID: 44,48  
 processings ...

[COMPOSITE]  
 TYPE: MODULE  
 UID: 101  
 contains UID 5,6,15,16  
 processings ...  
 [COMPOSITE]  
 TYPE: MODULE  
 UID: 102  
 contains UID 7,8,17,18  
 processings ...  
 [COMPOSITE]  
 TYPE: MODULE  
 UID: 103  
 contains UID 11,12,19,20  
 processings ...

[COMPOSITE]  
 TYPE: LAYER  
 UID: 201  
 contains UID 21,22,23,24,25  
 processings ...  
 [COMPOSITE]  
 TYPE: LAYER  
 UID: 202  
 contains UID 101,102  
 contains UID 3,4,9  
 processings ...  
 [COMPOSITE]  
 TYPE: LAYER  
 UID: 203  
 contains UID 26,27,28,29,30  
 processings ...

[COMPOSITE]  
 TYPE: LAYER  
 UID: 204  
 contains UID 41,42,43,44  
 processings ...  
 [COMPOSITE]  
 TYPE: LAYER  
 UID: 205  
 contains UID 103  
 contains UID 10,13  
 processings ...  
 [COMPOSITE]  
 TYPE: LAYER  
 UID: 206  
 contains UID 45,46,47,48  
 processings ...

[COMPOSITE]  
 TYPE: ELEMENT  
 UID: 301  
 contains UID 201,202,203  
 processings ...  
 [COMPOSITE]  
 TYPE: ELEMENT  
 UID: 302  
 contains UID 204,205,206  
 processings ...

[COMPOSITE]  
 TYPE: ELEMENTCHARGE  
 UID: 401  
 contains UID 301,302  
 contains UID 1,2  
 processings ...

End of example for a composite

Example ELEMENT with LAYERS

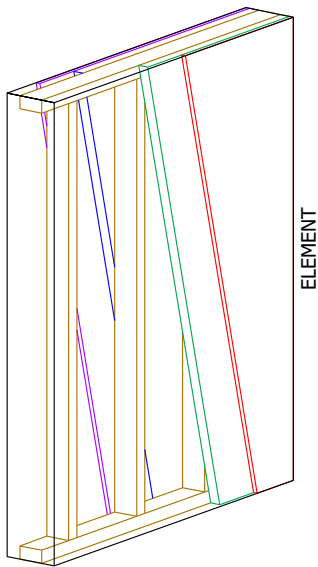

Example LAYERS

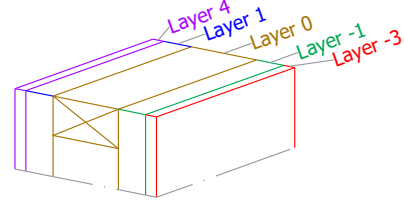
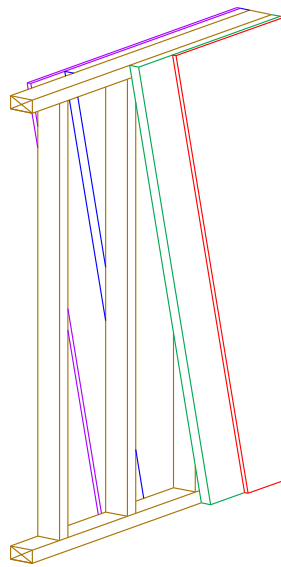

Each ELEMENT must have a LAYER 0.  
 The LAYER numbers must be unique.  
 In the [COMPOSITE]s with "TYPE: ELEMENT" the Attribute "REFERENCESIDE:" must be set.  
 LAYER with number = 0: On center of ELEMENT  
 Positive LAYER numbers: On REFERENCESIDE of ELEMENT  
 Negative LAYER numbers: On opposite REFERENCESIDE of ELEMENT

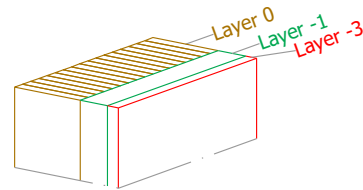
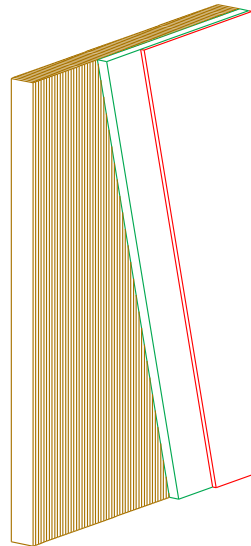
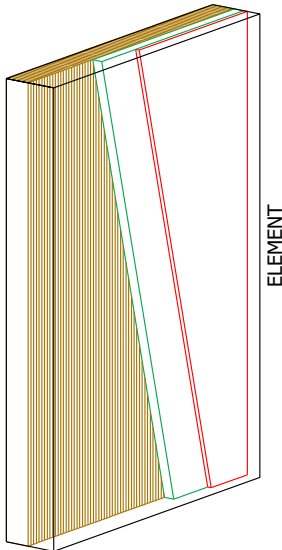

ditto

Example productions steps on machine

The machine decides the order of production and the count of steps.  
 LAYER 0 defines the start situation.

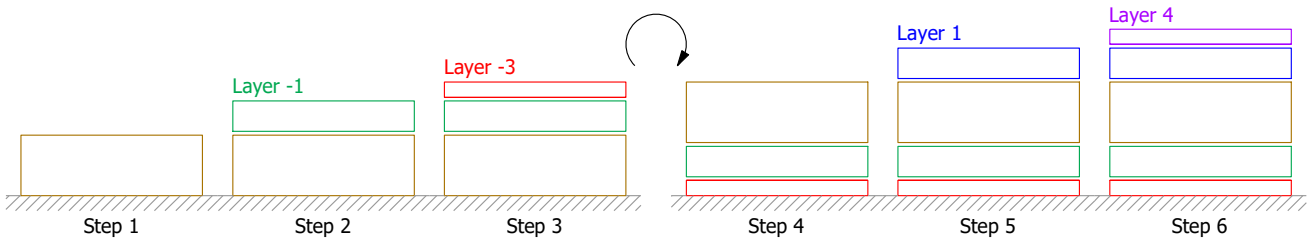

or

